

# AGRAS T50 (Type: 3WWDZ-40B)

# AGRAS T25 (Type: 3WWDZ-20B)

## Unmanned Aircraft Flight Manual

v1.0 2025.01

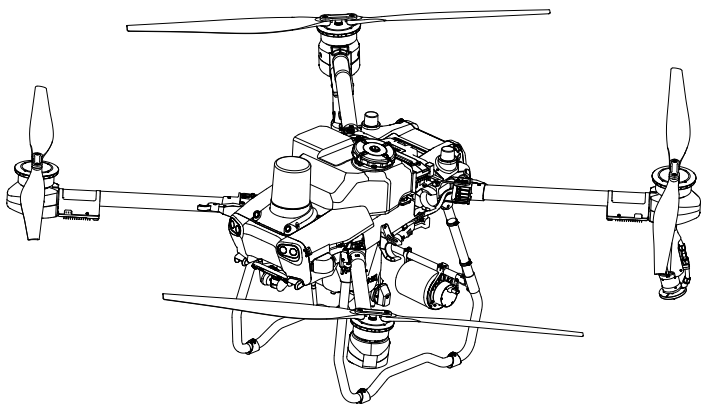
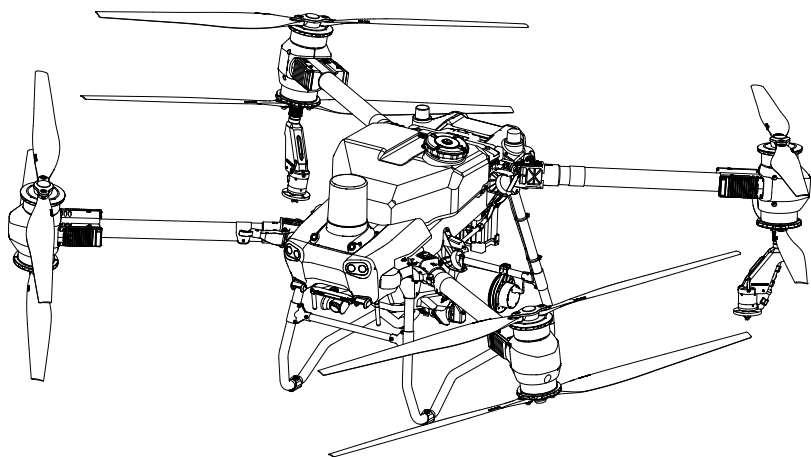



This document is copyrighted by DJI with all rights reserved. Unless otherwise authorized by DJI, you are not eligible to use or allow others to use the document or any part of the document by reproducing, transferring or selling the document. Users should only refer to this document and the content thereof as instructions to operate DJI UAV. The document should not be used for other purposes.

### **Searching for Keywords**

Search for keywords such as “battery” and “install” to find a topic. If you are using Adobe Acrobat Reader to read this document, press Ctrl+F on Windows or Command+F on Mac to begin a search.

### **Navigating to a Topic**

View a complete list of topics in the table of contents. Click on a topic to navigate to that section.

### **Printing this Document**

This document supports high resolution printing.

- 
-  • The T50 aircraft and T25 aircraft have similar functions and operations. Unless otherwise specified, descriptions in this document use the T25 aircraft as an example and apply to both aircraft models.
-

## Information

The aircraft may not come with a flight battery in certain regions. Only purchase official DJI™ flight batteries. Read the corresponding Intelligent Flight Battery user guide and take necessary precautions when handling the batteries to ensure your own safety. DJI assumes no liability for damage or injury incurred directly or indirectly from misusing batteries.

## Using This Manual

### Legend

 Important

 Hints and tips

 Reference

### Before Flight

The following documents have been produced to help you safely operate and make full use of your aircraft:

1. In the Box
2. Disclaimer and Safety Guidelines
3. Quick Start Guide
4. User Manual (Unmanned Aircraft Flight Manual)

Refer to the corresponding In the Box to check the listed parts and read the disclaimer and safety guidelines before flight. Refer to the quick start guide for more information on assembly and basic operation. Refer to the user manual for more comprehensive information.

### Downloading DJI Assistant 2 (MG Series)

Download DJI ASSISTANT™ 2 (MG Series) from:

<https://www.dji.com/downloads/softwares/assistant-dji-2-for-mg>

### Downloading DJI SmartFarm App

Scan the QR code to download DJI SmartFarm, which provides end-to-end service support for the operation.



- 
-  • The operating temperature of this product is 0° to 45° C (32° to 113° F). It does not meet the standard operating temperature for military grade application (-55° to 125° C (-67° to 257° F)), which is required to endure greater environmental variability. Operate the product appropriately and only for applications that it meets the operating temperature range requirements of that grade.
-

# Contents

<b>Using This Manual</b>	<b>1</b>
Legend	1
Before Flight	1
Downloading DJI Assistant 2 (MG Series)	1
Downloading DJI SmartFarm App	1
<b>General Information and System Description</b>	<b>6</b>
Introduction	6
Aircraft	7
Feature Highlights	7
Aircraft Overview	8
Flight Control Surfaces	10
Propulsion System	10
Avionics	10
Control Station	14
Profile	14
Remote Controller Overview	15
Using the Remote Controller	17
Remote Controller LEDs	23
Remote Controller Alert	23
Linking the Remote Controller	23
Operating the Touchscreen	24
Advanced Features	26
DJI Agras App (Information Display and User Interface)	26
Command and Control Link	30
Ground Operational Area Setup	30
<b>Performance and Limitations</b>	<b>31</b>
Performance	31
T50	31
T25	31
Prohibited Maneuvers	32
Center of Gravity Limitations	32
T50	33
T25	34
Applicable Environmental Limitations	35

<b>Normal Procedures</b>	<b>36</b>
Airspace Environment	36
Operation Environment	36
GEO (Geospatial Environment Online) System	36
Flight Limits	37
Radio Frequency Environment	39
Use of Launch and Recovery Equipment	39
Distance to Control Station	39
System Assembly	40
Preparing the Aircraft	40
Preparing the Remote Controller	41
Pre-Flight Checklist	43
System Starting	44
Calibrating the Flow Meter	44
Calibrating the Compass	45
Takeoff/Landing	46
Takeoff	46
Landing	46
Cruise / Maneuvering Flight	47
Operating the Aircraft	47
Flight Modes	48
Mapping Operation Modes	48
Spraying Operation Modes	50
System Shutdown	61
Post-Flight Inspection	61
<b>Emergency Procedures</b>	<b>62</b>
General Information	62
Engine Failure	62
Fire 62	
Loss of C2 Link	63
Failsafe RTH	63
RTH Safety Notices	63
Obstacle Avoidance During RTH	64
Landing Protection Function	64

Loss of Navigation Systems	64
Control Station Failures	64
Flyaway	65
Reporting Requirements	65
<b>Weight and Balance and Equipment List</b>	<b>66</b>
<b>Handling, Servicing and Instructions for Maintenance and Continued Airworthiness</b>	<b>66</b>
Ground Handling	66
Disassembly, Storage, and Reassembly	66
Tank	67
Sprinklers	68
Propellers	68
Storage	69
Charging / Conditioning / Replacing Batteries	70
Charging Batteries	70
Conditioning Batteries	72
Replacing Batteries	72
Maintenance Program	72
Operator Performing List	72
Notice	73
<b>Supplements</b>	<b>74</b>
Specifications	74
T50	74
T25	77
Operation Resumption	81
Recording a Breakpoint	81
Resuming Operation	81
Typical Applications	82
System Data Protection	83
Empty Tank Warning	83
Profile	83
Usage	84
Return to Home (RTH)	84
Smart RTH	84
Low Battery RTH	84

Failsafe RTH	84
Updating the Home Point	85
Low Battery and Low Voltage Warnings	85
RTK Functions	85
Enable/Disable RTK	86
Using with the DJI D-RTK 2 Mobile Station	86
Using with the Network RTK Service	86
Aircraft LEDs	87
Updating the Firmware	88
DJI Assistant 2 (MG Series)	88
Installation and Launching	88
Using DJI Assistant 2 (MG Series)	88
Intelligent Flight Battery	89
Battery Functions	89
Using the Battery	90
LED Patterns	92
Battery Storage and Transportation	94
Battery Disposal	94
Battery Maintenance	95
Specifications	96
Payload - Spraying System	97
Introduction	97
Spraying Operation Parameters	97
Specifications	97
Optional Payload - T50/T25 Spreading System	98
Introduction	98
Installation	98
Specifications	100
T50/T25 Drone Recommended Maintenance Cycle	101
FAR Remote ID Compliance Information	104

# General Information and System Description

## Introduction

The Agras T50 aircraft has an anti-torsion structure, offering reliable operations. The Agras T25 aircraft has a truss-style design with arms that can be folded to reduce the body size, making the aircraft easier to transport. The integrated spraying system can be swapped with a spreading system. The spreading payload of the T50 has increased to 50 kg for more efficient spreading.

The aircraft is equipped with the phased array radar system and binocular vision system. The systems provide multidirectional obstacle sensing<sup>[1]</sup> as well as terrain follow and bypass functions to ensure flight safety. Boasting an ultra HD FPV camera with tiltable gimbal, the aircraft can automatically collect HD field images for local offline reconstruction to assist in precise field planning. Using DJI SmartFarm platform and DJI MAVIC™ 3M, prescription maps can be generated in order to perform variable rate fertilization.

The spraying system is equipped with the magnetic drive impeller pumps, dual atomizing sprinklers, and solenoid valve. When used with the weight sensors, the spraying system provides real-time liquid level detection and improves spraying efficiency while saving liquid pesticide.

Core modules adopt potting technology and has a protection rating of IP67 (IEC 60529).

The DJI RC Plus (Agras) remote controller features DJI O3 Agras image transmission technology.<sup>[2]</sup> Operations are more convenient and accurate than ever before thanks to the revamped DJI Agras app design and a wide range of buttons on the remote controller. With Mapping mode added to the app, users can complete offline reconstructions and perform precise field planning without the need of extra devices.

[1] The downward sensing system is used to assist in Terrain Follow, while the sensing function on the other sides is for obstacle sensing.

[2] The remote controller is able to reach its maximum transmission distance (FCC/NCC: 7 km (4.35 mi); SRRRC: 5 km (3.11 mi); CE/KCC/MIC: 4 km (2.49 mi)) in an open area with no electromagnetic interference, and at an altitude of approximately 2.5 m (8.2 ft).

## Aircraft

### Feature Highlights

Folding detection sensors built into the frame arms enable the aircraft to perform a folding mechanism self-check, ensuring the arms are properly unfolded. The aircraft supports centimeter-level positioning<sup>[1]</sup> when used with the onboard D-RTK™.

The aircraft is equipped with the phased array radar system and binocular vision system. The systems provide multidirectional obstacle sensing<sup>[2]</sup>, making the aircraft avoiding obstacles along the operation route to ensure fly safety and improve the operation efficiency.

The Mapping mode supports terrain-follow aerial surveying for orchards with slopes within 20° to reconstruct the orchard HD map and three-dimensional operation routes. Terrain Follow function ensures the aircraft fly at a constant distance to operate even spraying.

Using the T50/T25 atomizing sprinkler package, the spraying system on the aircraft can be expanded from two sprinklers to four sprinklers with the max flow improved to 24 L/min, meeting large flow spraying operation requirements.

With the upgraded DJI Agras app, operation planning is more convenient than ever, the payload for each flight is maximized through intelligent route planning for greater efficiency. Connection point is enabled in return path for safer flight.

- [1] Must be used with a DJI D-RTK 2 High Precision GNSS Mobile Station (sold separately) or a DJI-approved Network RTK service.
- [2] The downward sensing system is used to assist in Terrain Follow, while the sensing system on the other sides is for obstacle sensing.

# Aircraft Overview

## T50

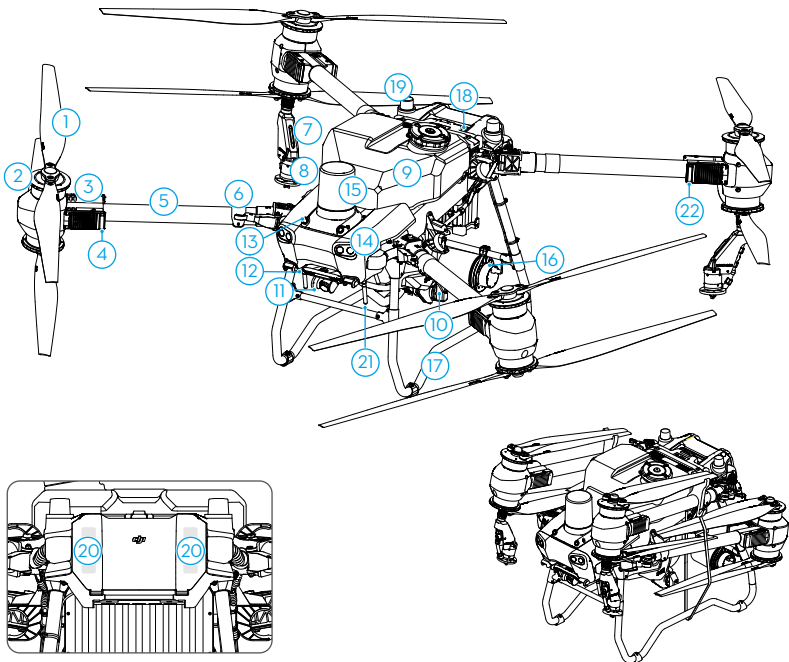

Rear View

Folded

- |  |                                |   |
|--|--------------------------------|---|
| 1. Propellers                                    | 9. Spray Tank                  | 18. Intelligent Flight Battery                    |
| 2. Motors  | 10. Delivery Pumps             | 19. Onboard D-RTK Antennas                        |
| 3. ESCs  | 11. FPV Camera                 | 20. Internal Ocusync™ Image Transmission Antennas |
| 4. Aircraft Front Indicators (on two front arms) | 12. Downward Binocular Vision  | 21. External OcuSync Image Transmission Antennas  |
| 5. Frame Arms                                    | 13. Forward Binocular Vision   | 22. Aircraft Status Indicators (on two rear arms) |
| 6. Folding Detection Sensors (built-in)          | 14. Spotlights                 |   |
| 7. Spray Lance                                   | 15. Forward Phased Array Radar |   |
| 8. Sprinklers                                    | 16. Rear Phased Array Radar    |   |
|  | 17. Landing Gear               |   |

T25

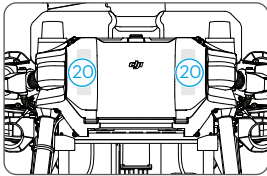
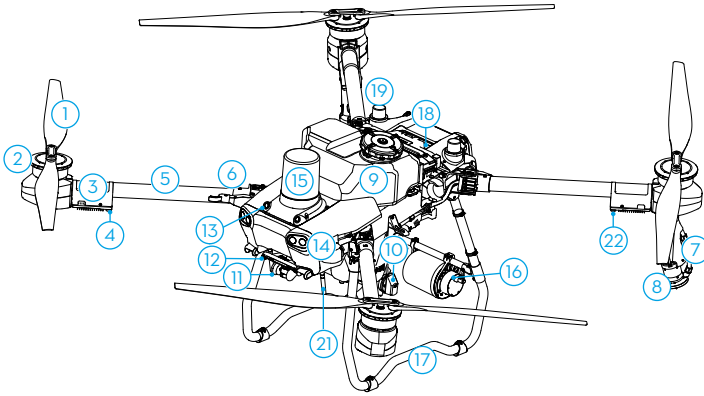

Rear View

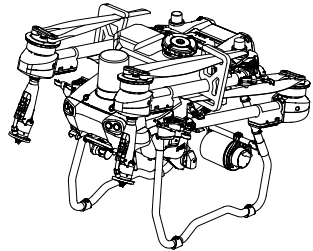

Folded

- |  |                                |   |
|--|--------------------------------|---|
| 1. Propellers                                    | 8. Sprinklers                  | 17. Landing Gear                                  |
| 2. Motors  | 9. Spray Tank                  | 18. Intelligent Flight Battery                    |
| 3. ESCs  | 10. Delivery Pumps             | 19. Onboard D-RTK Antennas                        |
| 4. Aircraft Front Indicators (on two front arms) | 11. FPV Camera                 | 20. Internal Ocusync Image Transmission Antennas  |
| 5. Frame Arms                                    | 12. Downward Binocular Vision  | 21. External OcuSync Image Transmission Antennas  |
| 6. Folding Detection Sensors (built-in)          | 13. Forward Binocular Vision   | 22. Aircraft Status Indicators (on two rear arms) |
| 7. Spray Lance                                   | 14. Spotlights                 |   |
|  | 15. Forward Phased Array Radar |   |
|  | 16. Rear Phased Array Radar    |   |

## Flight Control Surfaces

Not applicable for multicopters.

## Propulsion System

The propulsion system consists of motors, ESCs, and folding propellers, to provide stable and powerful thrust.

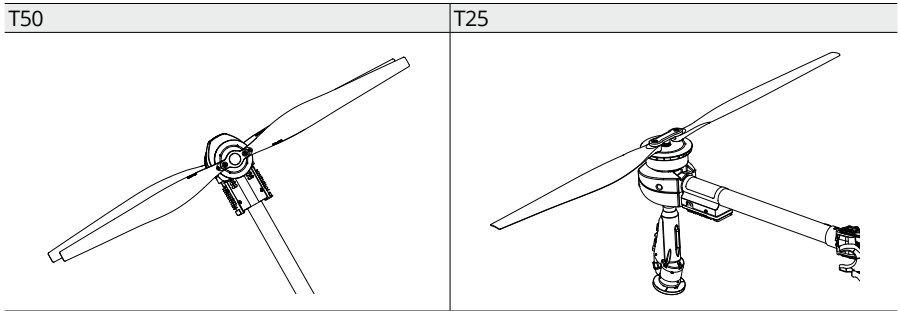

## Avionics

The avionics includes an aerial-electronics system, image transmission system, binocular vision and radar system, spraying control board, and FPV module.

## Flight Control and Navigation System

The flight control and navigation system built into the aircraft is integrated with modules such as the flight controller, IMU, barometer, GNSS receiver, RTK module, and compass, providing stable and reliable navigation and control. The dedicated industrial flight controller provides multiple flight modes and operation modes for various applications. The GNSS+RTK dual-redundancy system is compatible with multiple positioning systems. The aircraft also supports centimeter-level positioning when used with the built-in onboard D-RTK antennas. Dual-antenna technology provides strong resistance against magnetic interference.

## Communication Equipment

The aircraft boasts two OcuSync image transmission antennas and DJI O3 Agram image transmission system, offering a maximum transmission range of 7 km for communication with the remote controller.

## FPV Module

Equipped with the UHD FPV camera with a tiltable gimbal, the aircraft can automatically collect HD field images for local offline reconstruction to assist in precise field planning. Furthermore, the bright spotlights double the night vision capabilities of the aircraft, creating more nighttime operation possibilities.

## Binocular Vision and Phased Array Radar (Detection and Obstacle Avoidance System)

### Profile

The aircraft is equipped with the phased array radar system and binocular vision system. The systems provide multidirectional obstacle sensing<sup>[1]</sup> as well as terrain follow and bypass functions to ensure flight safety. In an optimal operating environment, the radar module can help the aircraft to fly above the vegetation at a constant distance and ensure even spraying and terrain following. In addition, the flight control system limits the descent speed of the aircraft according to the distance between the aircraft and ground detected by the radar module to achieve a smooth landing.

The binocular vision system is enabled automatically when the aircraft is in use. In Route and A-B Route operation modes, users can enable the terrain follow and bypassing functions for different terrain types. The aircraft will fly above the vegetation at a constant spraying distance and bypass detected obstacles. In Manual and Fruit Tree operation modes, the radar can measure the spraying distance above the vegetation or other surfaces. Obstacle avoidance can be used in any mode.

[1] The downward sensing system is used to assist in Terrain Follow, while the sensing function on the other sides is for obstacle sensing.

### Detection Range of Binocular Vision System and Radars

Binocular vision system: 90° (horizontal), 106° (vertical), 0.5-29 m.

Forward phased array radar: 360° (horizontal), ±45° (vertical), ±45° (upward, cone), 1-50 m.

Rear phased array radar: 360° (vertical), ±45° (horizontal), 1-50 m.

Note that the aircraft cannot sense obstacles that are not within its detection range. Fly with caution.



- The effective detection range varies depending on the size and material of the obstacle. When sensing objects such as buildings that have a radar cross section (RCS) of more than -5 dBsm, the effective detection range is 50 m. When sensing objects such as power lines that have a RCS of -10 dBsm, the effective detection range is approximately 30 m. When sensing objects such as dry tree branches that have a RCS of -15 dBsm, the effective detection range is approximately 20 m. Obstacle sensing may be affected or unavailable in areas outside of the effective detection distance.
  - Fly with caution when the aircraft is near an obstacle that is at a similar altitude with the bottom of the aircraft. The aircraft cannot detect the obstacle as most or even the whole obstacle is out of the detection range.
- 

### Omnidirectional Obstacle Avoidance Function



Enable the function in Sensor Settings, or tap the radar indicator in Operation View or press the button on the remote controller to enable obstacle avoidance. When enabled, the aircraft will enter obstacle avoidance mode when obstacles are detected. Users can control the aircraft to fly in a direction away from the obstacle according to the prompt in the app. Obstacle avoidance is used in the following two scenarios:

1. The aircraft begins to decelerate and hovers in place when it detects an obstacle. While decelerating, users can control the aircraft to fly in a direction away from the obstacle.

2. The aircraft immediately brakes and hovers if it detects an obstacle nearby. Users can fly the aircraft in a direction away from the obstacle to regain full control of the aircraft.

- 
-  • Obstacle avoidance is disabled during auto landing. Make sure to operate the aircraft with caution when controlling the aircraft manually during auto landing.
  - In some scenarios such as with power lines, small obstacles, or objects that are at the same level as the landing gear, obstacle sensing may be rendered ineffective. Fly with caution.
- 

## Terrain Follow and Bypassing Functions Usage

In Operation View, tap  > ) to enter Sensing Settings, and select the task terrain from the provided options such as Flatland, Mountains and Hilly Orchards, or Above Water in Sensing Settings. Altitude stabilization and obstacle bypassing can also be enabled in Sensing Settings. The aircraft will follow terrain automatically and adjust its altitude during flight based on the set height above crops, and bypass detected obstacles.

### Flatland



This mode is suitable for operations on flatlands or orchard fields without obvious surface elevation changes. When enabled, the aircraft will attempt to bypass obstacles from the side. Moving the control stick can pause auto bypassing. The aircraft will hover in place if auto bypassing fails. Users can manually bypass the obstacle by controlling the aircraft.

### Mountains and Hilly Orchards

This mode is suitable for operations on undulating terrain with mountain crops and fruit trees. When enabled, the aircraft will attempt to bypass obstacles by avoiding them from above. Moving the control stick can pause auto bypassing. The aircraft will hover in place if auto bypassing fails. Users can manually bypass the obstacle by controlling the aircraft.

### Above Water



This mode is suitable for operations above water. When enabled, the aircraft will attempt to bypass obstacles from the side. When Altitude Stabilization is enabled, the aircraft will use the Altitude Relative to Ground (Radar) for terrain following.

- 
-  • The max flight speed of the aircraft will be limited to 10 m/s and the height above vegetation will be limited from 2.5 m to 8 m when obstacle bypassing is enabled.
- 
-  • Choose the appropriate task terrain settings for the environment. Otherwise, the aircraft may not be able to keep the set height above crops or fail to bypass obstacles. For example:
    - a. When performing operations on flat, open spaces with Mountain and Hilly Orchards mode enabled, the aircraft will ascend abnormally in some instances such as when encountering power poles or trees.
    - b. When performing operations in hilly or mountainous areas with Flatland or Above Water mode enabled, the aircraft may fail to bypass obstacles from the side and spraying effectiveness may be adversely affected.
  - Only altitude stabilization is available in Manual mode. The aircraft will hover in place after encountering an obstacle instead of automatically bypassing them.

- When flying at night, in dark areas or the binocular vision sensors are dirty, the aircraft will use data measured by the radar for terrain following. Fly with caution.
- After the additional sprinklers are mounted, the performance of the binocular vision system may be affected by spray droplets. Fly with caution.
- In some scenarios such as with power lines or small obstacles, the bypassing function may not be able to bypass the obstacle successfully. Users can manually bypass the obstacle by controlling the aircraft.
- Terrain Follow will be affected when the aircraft is flying over water. Fly with caution. Make sure the relative flight altitude is higher than 2 m to avoid any accidents with the aircraft.

---

## Radar Usage Notice

-  • DO NOT touch or let your hands or body come in contact with the metal parts of the radar module when powering on or immediately after flight as they may be hot.
  - Maintain full control of the aircraft at all times and do not rely completely on the radar module and DJI Agras app. Keep the aircraft within VLOS at all times. Use your discretion to operate the aircraft manually to avoid obstacles.
  - In Manual operation mode, users have complete control of the aircraft. Pay attention to the flying speed and direction when operating. Be aware of the surrounding environment and avoid the blind spots of the radar module.
  - The obstacle avoidance function is disabled in Attitude mode.
  - When sensing objects such as an inclined line, inclined utility pole, or power line at an inclined angle against the flying direction of the aircraft, the radar detection performance will be affected since most of the radar electromagnetic waves are reflected to other directions. Fly with caution.
  - The radar module enables the aircraft to maintain a fixed distance from vegetation only within its working range. Observe the aircraft's distance from vegetation at all times.
  - Operate with extra caution when flying over inclined surfaces. The recommended maximum inclination at different aircraft speeds are 10° at 1 m/s, 6° at 3 m/s, and 3° at 5 m/s.
  - Comply with local radio transmission laws and regulations.
  - The sensitivity of the radar module may be reduced when operating several aircraft within a short distance. Operate with caution.
  - The radar module is a precision instrument. DO NOT squeeze, tap, or hit the radar module.
  - Before use, make sure that the radar module is clean and the outer protective cover is not cracked, chipped, sunken, or misshapen.
- 
-  • Keep the protective cover of the radar module clean. Clean the surface with a soft damp cloth and air dry before using again.
-

## Binocular Vision System Usage Notice

- 
- ⚠ • The performance of the binocular vision system is affected by light intensity and the patterns or texture of the surface being flown over. Operate the aircraft with great caution in the following situations:
    - a. Flying over monochrome surfaces (e.g., pure black, pure white, pure green).
    - b. Flying over highly reflective surfaces.
    - c. Flying over water or transparent surfaces.
    - d. Flying in an area where the lighting changes frequently or drastically.
    - e. Flying over extremely dark (< 10 lux) or bright (> 10,000 lux) surfaces.
    - f. Flying over surfaces with repeating identical patterns or textures or with particularly sparse patterns or textures.
  - Keep the cameras of the binocular vision system clean at all times.
  - Make sure that there are clear patterns and adequate lighting in the surroundings since the binocular vision system relies on images of the surrounding environment to obtain displacement data.
  - The obstacle sensing function of the binocular vision system may not work properly when the aircraft is operated in a dim environment or over water or surfaces without a clear pattern.
- 
- ☀ • Keep the cameras of the binocular vision system clean. Make sure that the aircraft is powered off. First remove any larger pieces of grit or sand then wipe the lens with a clean, soft cloth to remove dust or other dirt.
- 

## Control Station

### Profile

The DJI RC Plus (Agras) remote controller features DJI O3 Agras image transmission technology, and has a max transmission distance of up to 5 km (at an altitude of 2.5 m).<sup>[1]</sup> The remote controller has an 8-core processor and a built-in 7.02-in high brightness touchscreen powered by the Android operating system. Users can connect to the internet via Wi-Fi or the DJI Cellular Dongle. Operations are more convenient and accurate than ever before thanks to the revamped DJI Agras app design and a wide range of buttons on the remote controller. With Mapping mode added to the app, users can complete offline reconstructions and perform precise field planning without the need of extra devices. The remote controller has a maximum operating time of 3 hours and 18 min with the high-capacity internal battery. Users can also purchase an external battery separately to be used to supply power to the remote controller and fully meet the requirements for long and high-intensity operations.

[1] The remote controller is able to reach its maximum transmission distance (FCC/NCC: 7 km (4.35 mi); SRRC: 5 km (3.11 mi); CE/MIC: 4 km (2.49 mi)) in an open area with no electromagnetic interference and at an altitude of approximately 2.5 m (8.2 ft).

## Remote Controller Overview

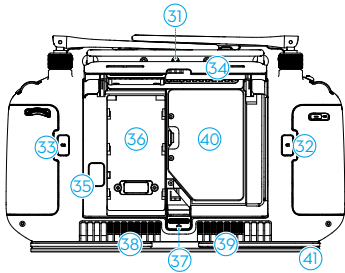
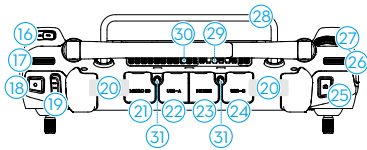
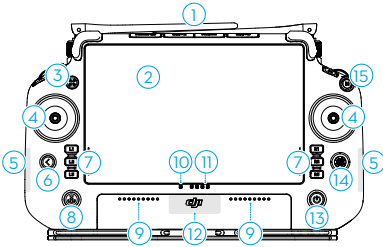

### 1. External RC Antennas

Relays the aircraft control and image transmission signal.

### 2. Touchscreen

Displays system and app views and supports up to 10 touch points. Android-based device for running the DJI Agram app.

### 3. Indicator Button (reserved)

### 4. Control Sticks

Controls aircraft movement. Control mode can be set in DJI Agram.

### 5. Internal Wi-Fi Antennas

Do not block the internal Wi-Fi antennas during use, otherwise the signals may be affected.

### 6. Back Button

Press once to return to the previous screen. Press twice to return to the home screen. Hold the back button and press another button to activate button combinations. Refer to the Button Combinations section for more information.

### 7. L1/L2/L3/R1/R2/R3 Buttons

When buttons are displayed in the app near these physical buttons or the prompts in the app include L1/L2/L3/R1/R2/R3, press the corresponding button on the remote controller to operate instead of tapping the touchscreen.

### 8. Return to Home (RTH) Button

Press and hold to initiate RTH. Press again to cancel RTH.

### 9. Microphones

### 10. Status LEDs

Indicates the status of the remote controller. Refer to Guide on the home screen for more information.

### 11. Battery Level LEDs

Displays the current battery level of the internal battery.

### 12. Internal GNSS Antennas

Do not block the internal GNSS antennas during use. Otherwise the positioning accuracy may be affected.

### 13. Power Button

Press once to check the current battery level. Press, and then press and hold to power the remote controller on or off. When the remote controller is powered on, press once to turn the touchscreen on or off.

### 14. 5D Button

### 15. Flight Pause Button (reserved)

### 16. Button C3

Customizable button.

- 17. Left Dial**

Turn to adjust the spray rate in Manual operation mode.
- 18. Spray/Spread Button**

Press to start or stop spraying/spreading in Manual operation mode.
- 19. Flight Mode Switch**

The three positions of the switch correspond to: N-mode (Normal), S-mode (Attitude), and F-mode (Normal).
- 20. Internal RC Antennas**

Relays aircraft control and image transmission signals. Do not block the internal RC antennas during use. Otherwise the signals may be affected.
- 21. microSD Card Slot**

Slot to insert a microSD card.
- 22. USB-A Port**

For connecting devices such as the RTK Dongle. When it is connected to the intelligent charger or multifunctional inverter generator, users can view the device status information in DJI Agras.
- 23. HDMI Port**

The output of the HDMI signal to an external monitor.
- 24. USB-C Port**

For charging the remote controller or connect to a computer to update firmware and export logs via the DJI Assistant 2 software.
- 25. FPV/Map Switch Button**

In Operation View in DJI Agras, press to switch between FPV and Map View.
- 26. Right Dial**

Turn to adjust the tilt of the FPV camera.
- 27. Scroll Wheel (reserved)**
- 28. Handle**
- 29. Speaker**
- 30. Air Vent**

For heat dissipation. Do not block the air vent during use.
- 31. Reserved Mounting Holes**
- 32. Button C1**

In Route (A-B) operation mode, press to record Point A.  
In Manual Plus operation mode, press to steer the aircraft left.
- 33. Button C2**

In Route (A-B) operation mode, press to record Point B.  
In Manual Plus operation mode, press to steer the aircraft right.
- 34. Rear Cover**
- 35. Battery Release Button**
- 36. Battery Compartment**

For installing the WB37 Intelligent Battery.
- 37. Rear Cover Release Button**
- 38. Alarm**
- 39. Air Intake**

For heat dissipation. Do not block the air intake during use.
- 40. Dongle Compartment**

The USB-C connector in the compartment is used to connect the DJI Cellular Dongle.
- 41. Strap Bracket**

## Using the Remote Controller

### Powering the Remote Controller On and Off

Both the internal battery and external battery can be used to supply power to the remote controller. The battery level is indicated via the battery level LEDs on the remote controller or on the external battery. Follow the steps below to power on the remote controller:

1. When the remote controller is powered off, press the power button once to check the current battery level of the internal battery. Press the battery level button on the external battery to check the current battery level of the external battery. If the battery level is too low, recharge before use.
2. Press the power button once, then press and hold to power on the remote controller.
3. The remote controller beeps when powered on. The status LED glows solid green when linking is complete.
4. Repeat Step 2 to power off the remote controller.

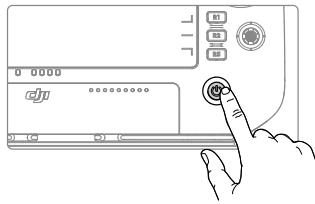

### Charging the Batteries

1. Use the DJI 65W Portable Charger to charge both the internal and external batteries simultaneously.

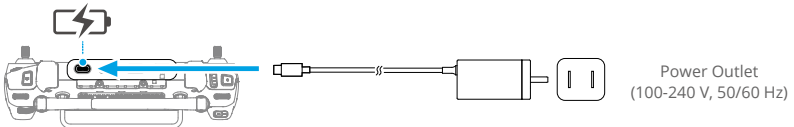

- Use the provided charger to charge the remote controller. Otherwise, use a locally certified USB-C charger with a maximum rated power and voltage of 65 W and 20 V.
- Fully charge and discharge the internal and external batteries of the remote controller at least once every three months. The battery will deplete when it is stored for an extended period.

2. Use the WB37 Battery Charging Hub (USB-C) and 65W Portable Charger to charge the external battery. Refer to the WB37 Battery Charging Hub (USB-C) User Guide for more information.

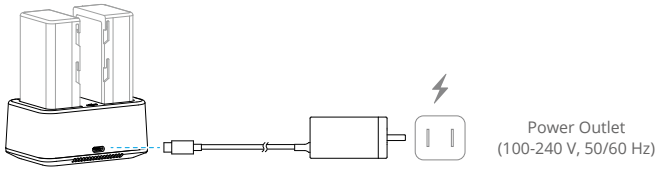

## Operating the Aircraft

This section explains how to control the orientation of the aircraft through the remote controller. Control can be set to Mode 1, Mode 2, or Mode 3.

### Mode 1

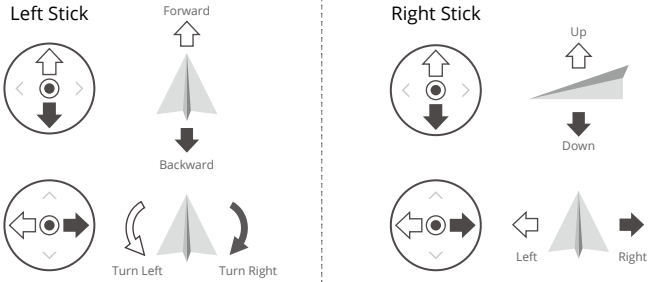



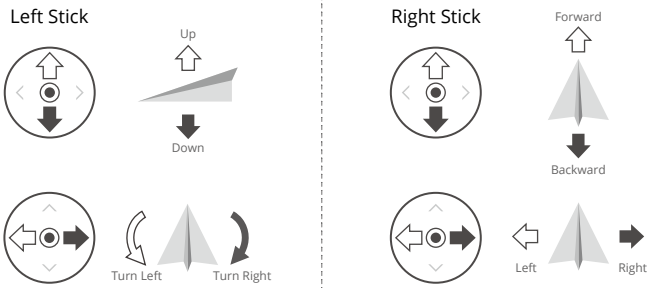

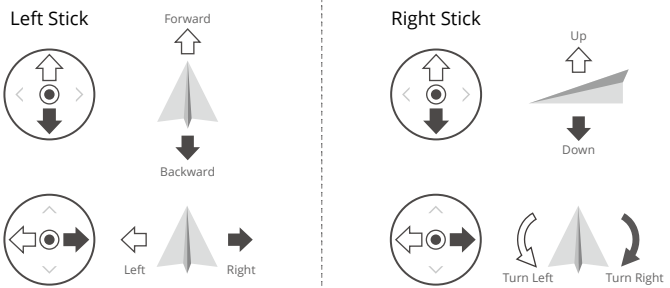

### Mode 2

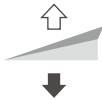

### Mode 3



For example, the following description uses Mode 2:

Remote Controller (Mode 2)	Aircraft	Remarks
<p>Left Stick</p> 		<p><b>Throttle Stick:</b> Move the left stick vertically to control the elevation of the aircraft.</p> <p>Push up to ascend and push down to descend. Use the left stick to take off when the motors are spinning at an idle speed. The aircraft hovers in place if the stick is in the center position. The further the stick is pushed away from the center position, the faster the aircraft changes elevation.</p>
<p>Left Stick</p> 		<p><b>Yaw Stick:</b> Move the left stick horizontally to control the heading of the aircraft.</p> <p>Push left to rotate the aircraft counterclockwise and push right to rotate clockwise. The aircraft hovers in place if the stick is in the center position. The further the stick is pushed away from the center position, the faster the aircraft rotates.</p>
<p>Right Stick</p> 		<p><b>Pitch Stick:</b> Move the right stick vertically to control the pitch of the aircraft.</p> <p>Push up to fly forwards and press down to fly backwards. The aircraft hovers in place if the stick is in the center position. Push the stick further for a larger pitch angle and faster flight.</p>
<p>Right Stick</p> 		<p><b>Roll Stick:</b> Move the right control stick horizontally to control the roll of the aircraft.</p> <p>Push the stick left to fly left and right to fly right. The aircraft hovers in place if the stick is in the central position. Push the stick further for a larger roll angle and faster flight.</p>

## Controlling the Spraying System

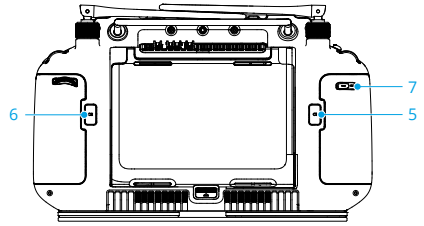
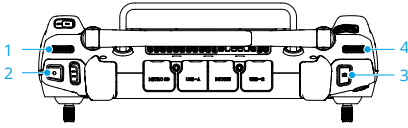

### 1. Left Dial

In Manual operation mode, turn left to reduce and right to increase the spray rate.\* The app indicates the current spray rate.

\* Spray rate may vary according to the sprinkler model and viscosity of the liquid.

### 2. Spray/Spread Button

In Manual operation mode, press to start or stop spraying.

### 3. FPV/Map Switch Button

In Operation View in DJI Agras, press to switch between FPV and Map View.

### 4. Right Dial

When the aircraft is not performing a Mapping operation, turn the dial to adjust the tilt of the FPV camera. The tilt cannot be adjusted during Mapping operations.

### 5. Button C1

Press to record Point A of the route in a Route (A-B) operation or steer the aircraft left in a Manual Plus operation.

### 6. Button C2

Press to record Point B of the route in a Route (A-B) operation or steer the aircraft right in a Manual Plus operation.

### 7. Button C3

In the DJI Agras app, tap > in the Operation View to customize the function of this button.

## Flight Mode Switch

Toggle the switch to switch between flight modes.

Position	Flight Mode
N	N-mode (Normal)
S	S-mode (mapped to A-mode, Attitude)
F	F-mode (Normal)

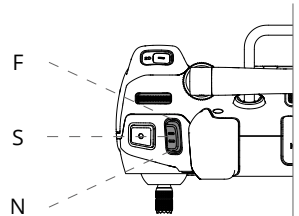

Regardless of the position the switch is in on the remote controller, the aircraft begins in N-mode by default. To switch flight modes, first go to Operation View in DJI Agras, tap , then , and enable "Allow Attitude Mode". After enabling Attitude mode, toggle the switch to N or F and then to S to switch the flight mode to Attitude mode.

The aircraft still begins in N-mode by default after powering on, even though A-mode was enabled in the app beforehand. When A-mode is required, toggle the Flight Mode switch as mentioned above after powering on the remote controller and aircraft.

## RTH Button

Press and hold the RTH button to bring the aircraft back to the last recorded home point. The LED around the RTH Button blinks white during RTH. Users can control aircraft altitude while it flies to the home point. Press this button again to cancel RTH and regain control of the aircraft.

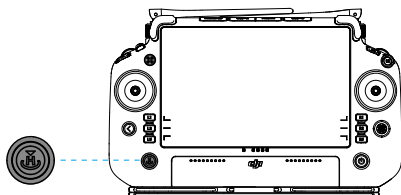

## Optimal Transmission Zone

Lift and adjust the antennas. The strength of the remote controller signal is affected by the position of the antennas. Adjust the direction of the external RC antennas of the remote controller so that the controller and aircraft are within the optimal transmission zone.

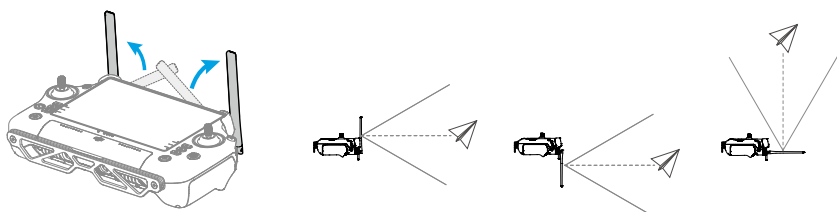

## Button Combinations

Some frequently-used features can be activated by using button combinations. Use the back button and the other button at the same time to execute a specific function.

Button Combinations	Description
Back Button + Left Dial	Adjust the screen brightness
Back Button + Right Dial	Adjust the system volume
Back Button + Spray Button	Record the screen
Back Button + FPV/Map Switch Button	Screenshot the screen
Back Button + 5D Button	Toggle up - Home; toggle down - Quick Settings; toggle left - Recently opened apps

## Remote Controller LEDs

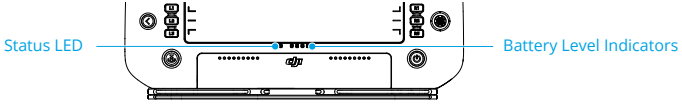

The battery level indicators display the battery level of the controller. The status LED displays the linking status and warnings for control stick, low battery level, and high temperature.

Blinking Patterns	Descriptions
Solid red	Disconnected with aircraft
Blinking red	Low aircraft battery level
Solid green	Connected with aircraft
Blinking blue	The remote controller is linking to an aircraft
Solid yellow	Firmware update failed
Blinking yellow	Low remote controller battery level
Blinking cyan	Control sticks not centered

Battery Level Indicators				Battery Level
<input type="checkbox"/>	<input type="checkbox"/>	<input type="checkbox"/>	<input type="checkbox"/>	75%~100%
<input type="checkbox"/>	<input type="checkbox"/>	<input type="checkbox"/>	<input type="checkbox"/>	50%~75%
<input type="checkbox"/>	<input type="checkbox"/>	<input type="checkbox"/>	<input type="checkbox"/>	25%~50%
<input type="checkbox"/>	<input type="checkbox"/>	<input type="checkbox"/>	<input type="checkbox"/>	0%~25%



## Remote Controller Alert

The remote controller vibrates or beeps to issue an error alert or warning. For detailed information, see the real-time prompts on the touchscreen or in the DJI Agras app. To disable some alerts, slide down from the top and select Do Not Disturb in Quick Settings.

Any voice prompts and alerts will be disabled in Silent mode, including alerts during RTH and low battery alerts for the remote controller or aircraft. Fly with caution.

## Linking the Remote Controller

The remote controller is linked to the aircraft by default. Linking is only required when using a new remote controller for the first time. When using the Multi-Aircraft Control function, it is required to link all aircraft to the same remote controller.

1. Power on the remote controller and open DJI Agras. Power on the aircraft.
2. Tap **Begin** to enter Operation View and tap , then . Tap **Linking** and then **Starting Linking**. The status LED blinks blue and the remote controller beeps twice repeatedly, indicating that the remote controller is ready for linking.

3. Press and hold the power button on the Intelligent Flight Battery for five seconds. The Intelligent Flight Battery LEDs blink in sequence, indicating that the linking is in progress.
4. The Status LED on the remote controller glows solid green if linking is successful. If linking fails, enter linking status again and retry.

## Operating the Touchscreen

### Home Screen

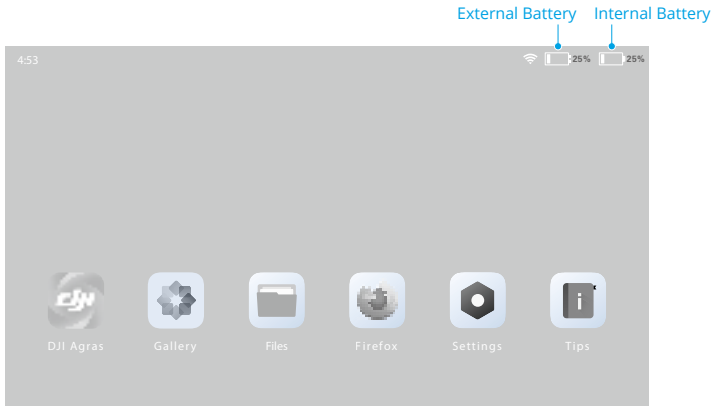

The top bar displays the time, network status, as well as battery levels of the internal and external batteries of the remote controller.

### Operations

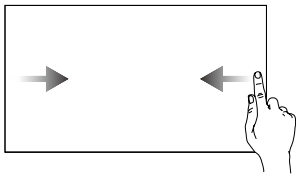

Slide from the left or right to the center of the screen to return to the previous screen.

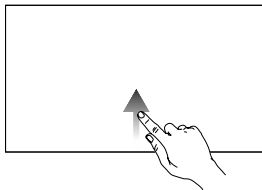

Slide up from the bottom of the screen to return to the home screen.

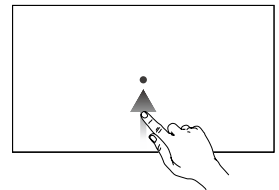







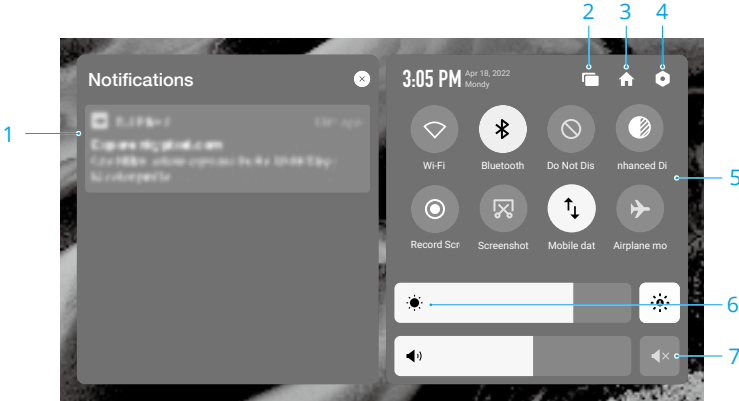







Slide up from the bottom of the screen and hold to access recently opened apps.

## Quick Settings

Slide down from the top to enter Quick Settings.



1. **Notifications**  
Tap to view system or app notifications.
2. **Recent**  
Tap  to view and switch to recently opened apps.
3. **Home**  
Tap  to return to the home screen.
4. **System Settings**  
Tap  to access system settings.
5. **Shortcuts**  
  -  : Tap to enable or disable Wi-Fi. Hold to enter settings and connect to or add a Wi-Fi network.
  -  : Tap to enable or disable Bluetooth. Tap and hold to open settings and connect with nearby Bluetooth devices.
  -  : Tap to enable DO NOT Disturb mode. In this mode, system prompts will be disabled.
  -  : Display enhancement. Once enabled, the display brightness is enhanced.
  -  : Tap to start screen recording.
  -  : Tap to screenshot the screen.
  -  : Mobile data. Tap to turn mobile data on or off; long press to set mobile data and diagnose network connection status.
  -  : Tap to enable Airplane mode. Wi-Fi, Bluetooth, and mobile data will be disabled.
6. **Adjust Brightness**  
Slide the bar to adjust the brightness. Tap the icon  to auto-brightness mode. Tap the  icon or slide the bar to switch to manual brightness mode.
7. **Adjust Volume**  
Slide the bar to adjust the volume and tap  to mute. Note that after muting, all sounds of the remote controller will be completely disabled, including related alarm sounds. Please turn on the mute with caution.

## Advanced Features

### Calibrating the Compass

After the remote controller is used in places with electro-magnetic interference, the compass may need to be calibrated. A warning prompt will appear if the remote controller's compass requires calibration. Tap the warning prompt to start calibrating. In other cases, follow the steps below to calibrate your remote controller.

1. Power on the remote controller and go to the home screen.
2. Tap Settings, scroll down and tap Compass.
3. Follow the diagram on the screen to calibrate your remote controller.
4. The user will receive a prompt when the calibration is successful.

### HDMI Settings

The touchscreen can be shared to a display after connecting the HDMI port of the remote controller. The resolution can be set by entering Settings, Display, and then Advanced HDMI.

## DJI Agras App (Information Display and User Interface)

DJI Agras is designed for agricultural applications. The app has a clear and concise interface and displays the status of the aircraft, spraying system, and other devices connected to the remote controller, and enables users to configure various settings. After planning a field via the intelligent operation planning system of the app, the aircraft can automatically follow the pre-planned flight route.



### Home Screen

1. **User Info**  
View account information.

## 2. Notification Center

Check notifications about any changes to the aircraft, users, or operations.

## 3. General Settings

Tap for settings such as units of measurement and privacy settings.

## 4. Document Management

View planned fields, operation progress, and resources such as prescription maps and reconstruction output. Tap a file to enter Operation View.

## 5. Log Upload

View solutions for errors of each module and upload error logs.

## 6. Device Management

Tap to check the device connection status and firmware version.

## 7. Aircraft Connection Status

Shows if the aircraft is connected to the remote controller.

## 8. Begin

Tap to enter Operation View.

# App Modes

DJI Agras provides two modes to make operating the aircraft accessible to users with any level of flying experience.

**Easy Mode:** This mode allows users to perform Route and Fruit Tree operations without complex parameter settings, which makes operating the aircraft accessible for beginners. In this mode, the aircraft will RTH by default when the spray tank is empty, RC signal is lost, battery level is low, or when an operation has been completed.

**Standard Mode:** In this mode, users can perform Route and Fruit Tree operations, as well as operate the aircraft manually. In this mode, the aircraft will hover by default when the spray tank is empty, RC signal is lost, or when an operation has been completed. The low battery action is set to warning by default.

Follow the steps below to switch the modes:

1. In Operation View, tap the mode switch button on the upper left part of the screen to enter the task mode selection screen.
2. Check the current operation mode on the upper left part of the screen and tap to select a different mode on the panel.

# Operation View

View the aircraft status, set parameters, switch between operation modes, plan a field, and perform operations in Operation View.

Slide from the left or right to the center of the screen to return to the home screen. Tap and hold the icons or buttons in Operation View to check function descriptions. The following section describes the other displayed information and the setting menu in Operation View.



**1. Field List/Task Settings**

Tap > to expand the list.

When the aircraft is not performing any operations, the field list will be displayed, users can view the planned fields and the operations being executed.

When an operation has been applied or started, the task settings will be displayed where users can set operation parameters. The adjustable parameters vary between different operation modes.

**2. FPV Camera View**

Displays the live view from the FPV camera. Tap to switch between Map View and FPV Camera View. Tap the icon on the upper right side of Operation View and select Aircraft Heading in the dropdown menu. The gridlines will be displayed in the FPV camera view.

**3. Overhead Obstacle Indicator**

If obstacle avoidance is enabled, a red zone will appear at the top of the screen when an overhead obstacle is detected. The distance between the obstacle and the aircraft will also be displayed.

**4. Radar Indicator**

Displays information such as the orientation of the aircraft and the Home Point. When Obstacle Avoidance is enabled, a frame will appear inside the radar indicator once detecting horizontal obstacles and the obstacle bar in the left of the radar indicator will show information of the detected vertical obstacles. Red, yellow, and green zones indicate the relative distance of the obstacles ranging from near to far. The value indicates the distance in meters or feet depending on the settings. Tap the radar indicator to enable or disable obstacle avoidance, altitude stabilization, or bypassing. There will be a red circle around the radar indicator when these functions are disabled.

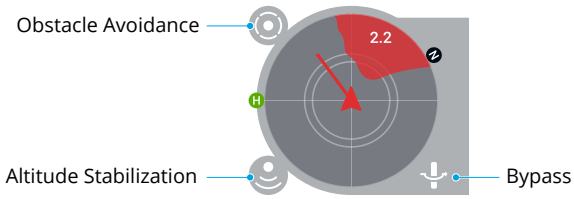

## 5. Flight Telemetry and Operation Status

**Altitude:** When the altitude stabilization function is enabled, it shows the height between the aircraft and the nearest object or ground underneath the aircraft. If the altitude stabilization function is disabled, it displays the altitude between the aircraft and the takeoff point. There are three different types of height:

👁️ **Altitude Relative to Ground (Vision & Radar):** If the vision system and radar are available and the distance between the aircraft and an object underneath is less than 10 m, it displays the altitude of the aircraft relative to the ground. This distance is measured by the vision system and radar.

📡 **Altitude Relative to Ground (Radar):** If the distance between the aircraft and an object underneath is more than 10 m, or the aircraft is flying over water, it displays the altitude of the aircraft relative to the ground, which is measured by the radar.

🏠 **Altitude Relative to Home Point:** If the vision system and radar are unavailable or the altitude stabilization function is disabled, it displays the difference between the altitude of the aircraft and the altitude of the takeoff point.

**Distance:** Displays the horizontal distance from the aircraft to the Home Point.

**Speed:** Displays the flight speed of the aircraft.

**Flow:** Displays the liquid flow rate.

**Area:** Displays the area values related to the task area.

## 6. Settings

Tap ⚙️ to enter the extended menu. View and adjust the parameters of all other settings via this menu.

✈️ **Aircraft Settings:** Includes linking with the aircraft and the remote controller, restoring unfinished tasks, and setting the connection routing and RTH, aircraft behavior, and flight optimization.

🌿 **Spraying System Settings:** Includes the spraying and spreading system switch, as well as cleaning and calibrating settings for the spraying system.

🕹️ **RC Settings:** Includes calibrating the remote controller, setting the control stick mode, button functions information, and customizable button settings.

📡 **Sensor Settings:** Includes omnidirectional obstacle avoidance, selection of operation scenarios, terrain follow, bypassing, radar sensitivity, side obstacle detection distance, and enhanced obstacle avoidance.

📶 **RTK Settings:** Includes RTK positioning switch, RTK signal source, and corresponding settings.

🔋 **Aircraft Battery:** Includes low battery actions, low battery warning threshold, and battery information.

📷 **HD Image Transfer Settings:** includes channel mode and sweep frequency chart selection.

## Command and Control Link

The command and control (C2) link between the aircraft and remote controller is established using DJI O3 Agras transmission technology with the two OcuSync antennas on the aircraft and DJI O3 Agras image transmission system, offering a maximum transmission range of 7 km. Its performance is listed below.

Operating Frequency*	2.4000-2.4835 GHz, 5.725-5.850 GHz
Transmitter Power (EIRP)	2.4 GHz: <33 dBm (FCC), <20 dBm (CE/SRRC/MIC) 5.8 GHz: <33 dBm (FCC), <14 dBm (CE), <23 dBm (SRRC)

\* 5.8 GHz frequency is prohibited in some countries.

## Ground Operational Area Setup

It is recommended to take off the aircraft in an open area. When taking off, the operator should be more than 10 m away from the aircraft.

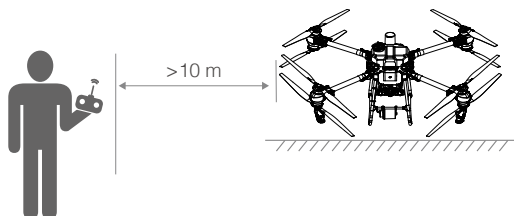

# Performance and Limitations

## Performance

### T50

Basic Empty Weight	52 kg
Max Takeoff Weight	Max takeoff weight for spraying: 92 kg (at sea level) Max takeoff weight for spreading: 103 kg (at sea level)
Top Speed/Never Exceed Speed	10 m/s (at sea level)
Endurance*	16.5 min (takeoff weight of 52 kg with a 30Ah battery) 7 min (takeoff weight of 92 kg with a 30Ah battery) 5.5 min (takeoff weight of 103 kg with a 30Ah battery)
Flight Battery	Type: Li-ion Capacity: 30 Ah Energy: 1567 Wh
Max Wind Resistance	6 m/s
Max Service Ceiling Above Sea Level	4500 m
Max Flight Range	2000 m

\* The endurance is tested in laboratory environment and is for reference only. The endurance under actual operating conditions will be reduced.

### T25

Basic Empty Weight	32 kg
Max Takeoff Weight	Max takeoff weight for spraying: 52 kg (at sea level) Max takeoff weight for spreading: 58 kg (at sea level)
Top Speed/Never Exceed Speed	10 m/s (at sea level)
Endurance*	14.5 min (takeoff weight of 32 kg with a 15.5 Ah battery) 7 min (takeoff weight of 52 kg with a 15.5 Ah battery) 6 min (takeoff weight of 58 kg with a 15.5 Ah battery)
Flight Battery	Type: Li-ion Capacity: 15.5 Ah Energy: 809 Wh
Max Wind Resistance	6 m/s
Max Service Ceiling Above Sea Level	4500 m
Max Flight Range	2000 m

\* The endurance is tested in laboratory environment and is for reference only. The endurance under actual operating conditions will be reduced.

## Prohibited Maneuvers

The following actions are prohibited.

1. Be under the influence of alcohol, drugs, or anesthesia, or suffering from dizziness, fatigue, nausea, or any other conditions, whether physical or mental, that could impair your ability to operate the aircraft safely.
2. Stop the motors mid-flight. NOTE: this is not prohibited in an emergency situation where doing so will reduce the risk of damage or injury.
3. Upon landing, power off the remote controller before powering off the aircraft.
4. Drop, launch, fire, or otherwise project any dangerous payloads on or at any buildings, persons, or animals, or which could cause personal injury or property damage.
5. Fly the aircraft recklessly without any plan.
6. Use this product for any illegal or inappropriate purpose such as spying, military operations, or unauthorized investigations.
7. Use this product to defame, abuse, harass, stalk, threaten, or otherwise violate the legal rights of others, such as the right of privacy and publicity.
8. Trespass onto private property of others.

## Center of Gravity Limitations

1. Using the M1 motor shaft as a reference, the center of gravity of the aircraft in the front-to-back direction ranges from 712 to 764.4 mm (for T50) and 661.2 to 704.2 mm (for T25), as shown in the diagram below.
2. Using the lowest point of the aircraft as a reference, the center of gravity in the vertical direction of the aircraft ranges from 553.6 to 557.8 mm (for T50) and 532.3 to 536.3 mm (for T25), as shown in the diagram below.
3. The center of gravity of the aircraft in the left-to-right direction should be the symmetrical center of the aircraft.

# T50

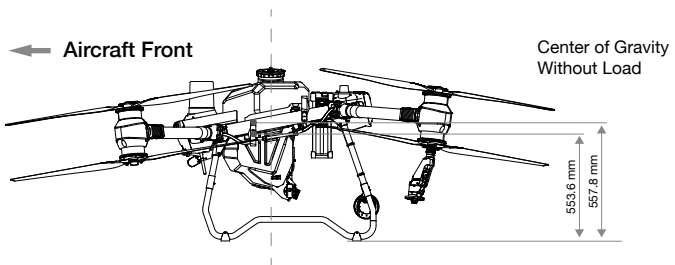
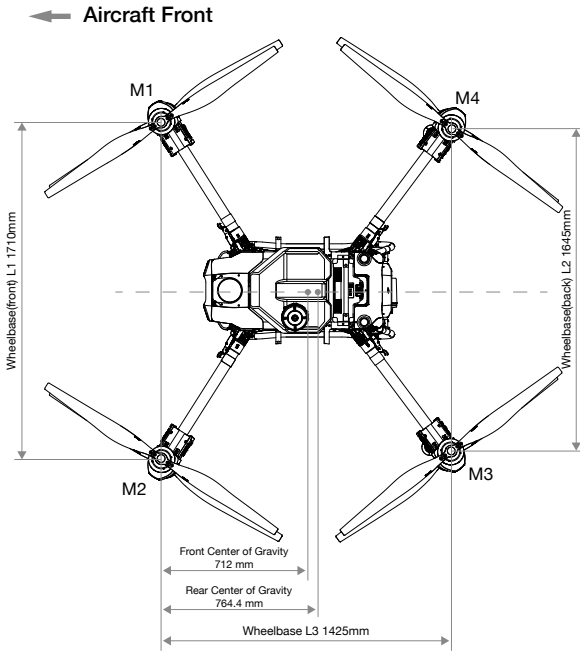

# T25

← Aircraft Front

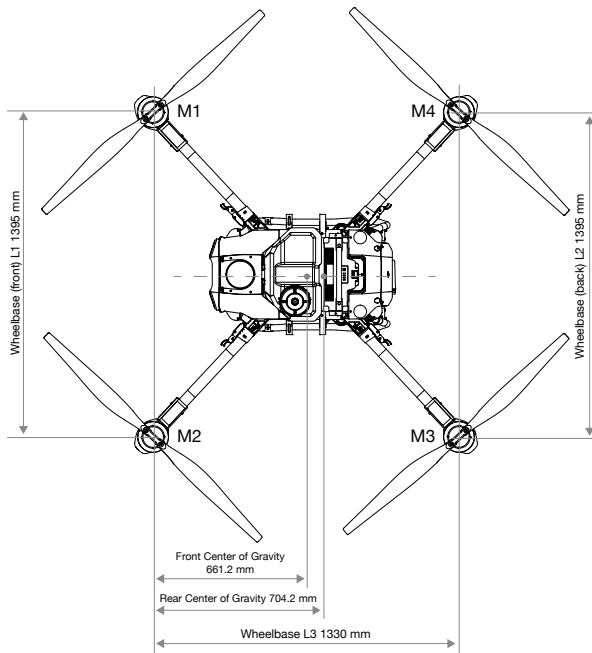

← Aircraft Front

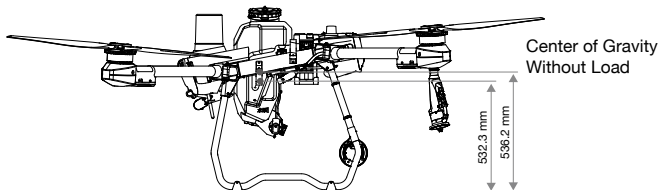

## Applicable Environmental Limitations

1. DO NOT use the aircraft in adverse weather conditions such as winds exceeding 6 m/s, rain, snow, or fog.
2. Aircraft and battery performance is subject to environmental factors such as air density and temperature. Be careful when flying 2 km (6,560 ft) or more above sea level as battery and aircraft performance may be reduced.
3. DO NOT use the aircraft near accidents, fire, explosions, floods, tsunamis, avalanches, landslides, earthquakes, dust, or sandstorms.
4. In low temperature environments (between 0° and 10° C (32° and 50° F)), make sure that the flight battery is fully charged and be sure to reduce the payload of the aircraft. Otherwise, it will affect the flight safety or a takeoff limit will occur.

# Normal Procedures

## Airspace Environment

The DJI Agras T50/T25 is a multi-copter crop protection RPAS mainly operated in farming, forestry, animal husbandry and fishery scenarios. Once pre-flight preparation is complete, it is recommended to hone your flight skills and practice flying safely. Make sure that all flights are carried out in an open area.

## Operation Environment

1. To avoid injury and damage and make sure spraying is effective, spray in winds lower than 6 m/s. It is recommended to spray in winds lower than 3 m/s for herbicides, fungicides, and insecticides that may drift and cause phytotoxicity and can be poisoning.
2. DO NOT use the aircraft in adverse weather conditions such as snow, fog, winds exceeding 6 m/s, or heavy rain exceeding 25 mm (0.98 in) in 12 hours.
3. Only fly in open areas. Tall buildings and steel structures may affect the accuracy of the compass and the GNSS signal.
4. Pay attention to utility poles, power lines, and other obstacles. DO NOT fly near or above water, people, or animals.
5. Maintain VLOS of the aircraft at all times, and avoid flying near obstacles, crowds, animals, and bodies of water.
6. Avoid flying in areas with high levels of electromagnetism, including mobile phone base stations and radio transmission towers.
7. DO NOT fly more than 4.5 km (14,763 ft) above sea level.
8. The DJI Agras app will intelligently recommend the payload weight limit for the tank according to the current status and surroundings of the aircraft. Do not exceed the recommended payload weight limit when adding material to the tank. Otherwise, the flight safety may be affected.
9. Make sure that there is a strong GNSS signal and the D-RTK antennas are unobstructed during operation.
10. DO NOT operate the aircraft indoors.

## GEO (Geospatial Environment Online) System

### GEO Zones

DJI's GEO System designates safe flight locations, provides risk levels and safety concerns for individual flights, and offers restricted airspace information. The locations designated by GEO are called GEO Zones. GEO Zones are specific flight areas that are categorized by flight regulations and restrictions. GEO Zones that prohibit flight are implemented around locations such as airports, power plants, and prisons. They can also be temporarily implemented around major stadium events, forest fires, or other emergency situations. Certain GEO Zones do not prohibit flight but do trigger warnings informing users of potential risks. All restricted flight areas are referred to as GEO Zones, and are further divided into Warning Zones, Enhanced Warning Zones, Authorization Zones, Altitude Zones, and Restricted Zones. By default, GEO limits flights into or taking off within zones that may result in safety or security concerns. There is a GEO Zone Map, which contains comprehensive global GEO Zone information on the official DJI website: <https://fly-safe.dji.com>.

The GEO System is for advisory purposes only. Individual users are responsible for checking official sources and determining which laws or regulations may apply to their flight. In some instances, DJI has selected widely-recommended general parameters (such as a 1.5-mile radius at airports) without making any determination as to whether these guidelines match regulations that apply to specific users.

## GEO Zone Definitions

**Warning Zones:** Users receive a warning message with information relevant to their flight.

**Enhanced Warning Zones:** Users receive a prompt from the GEO System at the time of flight. They are required to confirm their flight path.

**Authorization Zones:** Users receive a warning message and the flight is prohibited by default. Authorization Zones can be unlocked by authorized users with a DJI-verified account. Self-Unlocking privileges must be applied online.

**Altitude Zones:** Flights are limited to a specific altitude.

**Restricted Zones:** Flights are completely prohibited. UAVs cannot fly in these zones. If you have obtained permission to fly in a Restricted Zone, please go to <https://fly-safe.dji.com> or contact [flysafe@dji.com](mailto:flysafe@dji.com) to unlock the zone.

DJI GEO Zones aim to ensure the user's flight safety, but it cannot be guaranteed to be in full compliance with local laws and regulations. Users should check local laws, regulations, and regulatory requirements before each flight and are responsible for the flight safety.

All intelligent flight features will be affected when DJI aircraft fly nearby or into GEO Zones. Such interference includes, but is not limited to, decreased speed, takeoff failure, and flight termination.

## Flight Limits

Unmanned aerial vehicle (UAV) operators should abide by the regulations from self-regulatory organizations such as the International Civil Aviation Organization, the Federal Aviation Administration, and their local aviation authorities. For safety reasons, flight limits are enabled by default to help users operate this aircraft safely and legally. Users can set flight limits on height and distance.

When operating with a strong GNSS signal, the height and distance limits and GEO zones work together to monitor flight. With a weak GNSS signal, only the firmware height limit prevents the aircraft from going above 100 meters.

## Maximum Height and Radius Limits

Users can change the maximum height and radius limits in the app. Once completed, the aircraft flight is restricted to a cylindrical area that is determined by these settings. The tables below show the details of these limits.

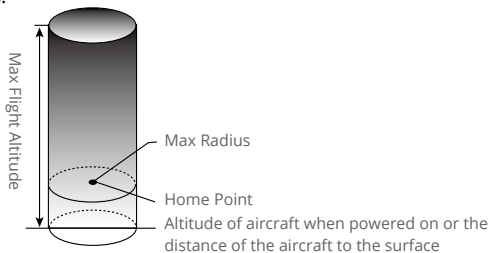

**With a strong GNSS signal**

**Flight Limits**

Max Height Flight altitude must be below the preset height.

Max Radius Flight distance must be within the max radius.

**With a weak GNSS signal**

**Flight Limits**

Max Height Flight altitude must be below the preset height.

Max Radius No limit.

- ⚠ • If the aircraft flies into a Restricted Zone, it can still be controlled, but the aircraft can only fly in a backward direction.
- If the aircraft loses GNSS signal and flies out of the max radius but regains GNSS signal later, it will fly back within range automatically.
- DO NOT fly near airports, highways, railway stations, railway lines, city centers, or other busy areas. Make sure the aircraft is visible at all times.

## GEO Zone Flight Restrictions

GEO Zone	Description
Restricted Zone	Takeoff: The aircraft's motors cannot be started.
	In-flight: When GNSS signal changes from weak to strong, the app starts a 100-second countdown. Once the countdown is over, the aircraft immediately lands in semi-automatic descent mode and turns off its motors after landing.
	In-flight: When the aircraft approaches the boundary of the Restricted Zone, it automatically decelerates and hovers.
Authorization Zone	Takeoff: The aircraft's motors cannot be started.
	In-flight: When GNSS signal changes from weak to strong, the app starts a 100-second countdown. Once the countdown is over, the aircraft immediately lands in semi-automatic descent mode and turns off its motors after landing.
Enhanced Warning Zone	The aircraft flies normally but the user is required to confirm the flight path.
Warning Zone	The aircraft flies normally but the user receives warning messages.
Altitude Zone	When GNSS signal is strong, the aircraft cannot exceed the specified altitude.
	In-flight: When GNSS signal changes from weak to strong, the aircraft will descend and hover below the altitude limit.

Altitude Zone	When the GNSS signal is strong, the aircraft approaches the boundary of the Altitude Zone. If it is higher than the altitude limit, the aircraft decelerates and hovers in place.
	When the GNSS signal changes from weak to strong, the app starts a 100-second countdown. Once the countdown is over, the aircraft will descend and hover below the altitude limit.
Free Zone	The aircraft flies normally with no restrictions.



- **Semi-Automatic Descent:** All stick commands except the throttle stick command and the RTH button are available during descent and landing. The aircraft motors will turn off automatically after landing. It is recommended to fly the aircraft to a safe location before the semi-automatic descent.

## Radio Frequency Environment

1. Avoid using wireless devices that use the same frequency bands as the remote controller.
2. When using with multiple aircraft, including T50, T25, and other aircraft, make sure that the distance between each aircraft is more than 10 m to avoid interference.
3. The sensitivity of the radar module may be reduced when operating several aircraft within a short distance. Operate with caution.
4. Be alert when flying near areas with magnetic or radio interference. These include, but are not limited to, high voltage lines, large scale power transmission stations or mobile base stations, and broadcasting towers. Failing to do so may compromise the transmission quality of this product or cause transmission errors which may affect flight orientation and location accuracy. The aircraft may behave abnormally or go out of control in areas with too much interference.
5. If the RTK dongle is used for field planning, the module should be disconnected from the remote controller after planning is completed. Otherwise, it will affect the communication performance of the remote controller.

## Use of Launch and Recovery Equipment

Not applicable.

## Distance to Control Station

When taking off or landing, the aircraft should be more than 10 m away from the remote controller and operator to ensure safety. Maintain visual line of sight with the aircraft at all times.

## System Assembly

### Preparing the Aircraft

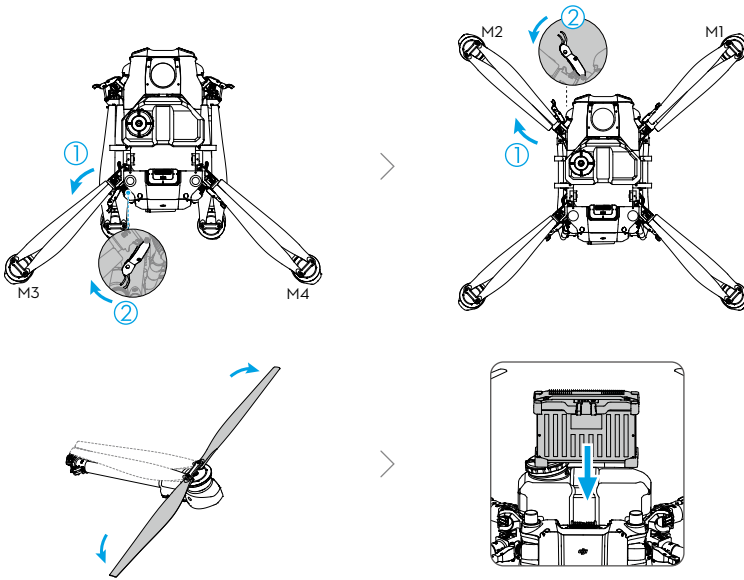

1. Unfold the M3 and M4 arms, and fasten the two arm locks. Avoid pinching fingers.
2. Unfold the M1 and M2 arms, and fasten the two arm locks. Avoid pinching fingers.
3. Unfold the propeller blades.
4. Insert the Intelligent Flight Battery into the aircraft until you hear a click.

The T50 uses the T50 Intelligent Flight Battery (model: BAX702-30000mAh-52.22V), while the T25 uses the T25 Intelligent Flight Battery (model: BAX702-15500mAh-52.22V). Check and charge the battery based on the requirements in the respective battery manual.

- ⚠ • Make sure that the battery is firmly inserted into the aircraft. Only insert or remove the battery when the aircraft is powered off.
- To remove the battery, press and hold the clamp and lift the battery up.
- When folding the arms, make sure to fold the M1 and M2 arms followed by the M3 and M4 arms and make sure that the arms are inserted into the storage clamps on both sides of the aircraft. Otherwise, the arms may be damaged.

## Preparing the Remote Controller

### Mounting the WB37 Intelligent Battery

Follow the instructions below to mount the battery if using the WB37 Intelligent Battery for the remote controller power supply.

1. Push the rear cover release button to the end to open the rear cover.
2. Insert the WB37 battery into the battery compartment and push it to the top. There will be a clicking sound to indicate the battery is installed firmly.
3. Close the rear cover.

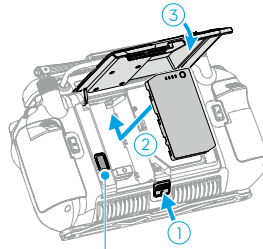

Battery Release Button



- To remove the WB37 battery, press and hold the battery release button and push the battery downward.

## Mounting the Dongle and SIM Card

- ⚠ • Dongle related functions are not supported in some countries or regions. Comply with the local laws and regulations.
- Only use a DJI-approved dongle (name: DJI Cellular Dongle (LTE USB Modem), model: IG830).
- The dongle and nano-SIM card enable the remote controller to access specific networks and platforms such as DJI Agras Intelligent Cloud. Make sure to insert them correctly. Otherwise, network access will not be available.

1. Press the rear cover release button to open the rear cover ①. Remove the screws ② and open the dongle compartment cover ③.
2. Insert the nano-SIM card into the dongle ④. Insert the dongle into the USB-C connector in the dongle compartment ⑤. Close the dongle compartment cover ⑥.
3. Remount the screws ⑦. Close the rear cover ⑧.

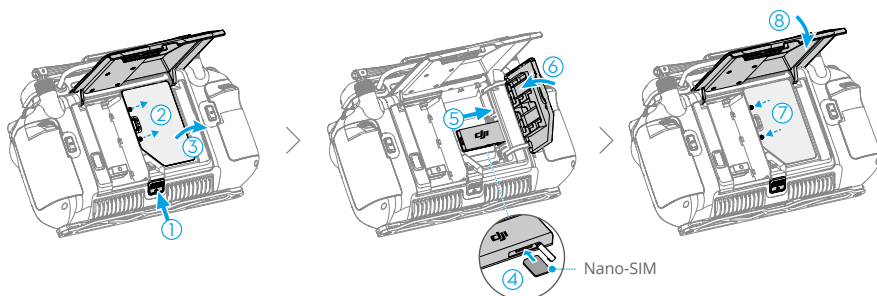

## Mounting the RTK Dongle

When adding points with the remote controller to plan the operation area, attach the RTK dongle connector (for DJI RC Plus) and RTK dongle to the remote controller for more precise positioning.

1. Mount the RTK dongle connector to the USB-A port on remote controller and tighten the two screws.
2. Mount the RTK dongle to the RTK dongle connector.

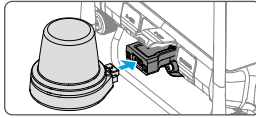

## Adjusting the Antennas

Lift and adjust the antennas. The signal strength of the remote controller is affected by the position of the antennas.

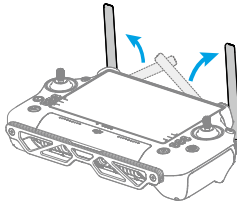

## Activating the Internal Battery

The internal battery must be charged before using for the first time. Connect the 65W portable charger to the USB-C port on the remote controller and connect the charger to a power outlet. The battery level LEDs will start to flash to indicate that the internal battery is activated.

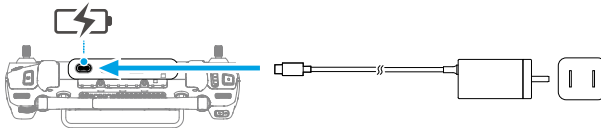

## Pre-Flight Checklist

1. Make sure the remote controller and aircraft battery are fully charged. The pesticides are adequate.
2. Make sure the spray tank and Intelligent Flight Battery are firmly in place.
3. Make sure all parts are mounted securely.
4. Make sure all cables are connected properly and firmly.

5. Make sure propellers are securely mounted, that there are no foreign objects in or on the motors and propellers, that the propeller blades and arms are unfolded, and the arm locks are firmly tightened.
6. The FPV camera and binocular vision system are clean and in good condition.
7. Make sure the spraying system is not blocked in any way.
8. Make sure the sprinkler hoses are clear from bubbles. Discharge any bubbles as they may affect the performance of the sprinkler.

## System Starting



1. Press the power button on the remote controller and then press and hold to power on the remote controller. Make sure that DJI Agras is open.
2. Press the power button on the Intelligent Flight Battery and then press and hold to power on the aircraft.
3. Check the home screen in DJI Agras to make sure that the aircraft is connected to the remote controller.
4. If using RTK for positioning, make sure that the RTK signal source is correctly set (D-RTK 2 Mobile Station or Network RTK service). Go to Operation View in the app, tap  and select RTK to view and set.  
Set the RTK signal source to None if RTK positioning is not in use. Otherwise, the aircraft is not able to take off when there is no differential data.
5. Wait for satellites to be searched, make sure that there is a strong GNSS signal, and make sure the aircraft heading measurement using the dual antennas is ready. (If the dual antennas are not ready after waiting for an extended period, move the aircraft to an open area with a strong GNSS signal.)

## Calibrating the Flow Meter

### When to Recalibrate



1. Using a liquid of a different viscosity.
2. The error between the actual value and the theoretical value of the completed area is more than 15%.

### Calibrating Procedure

1. Fill the spray tank with approximately 2 L of water.
2. In the app, go to Operation View, tap  > , and Spraying System Calibration, then tap Calibration on the right side of the flow meter calibration section.
3. Tap Start Calibration and calibration will start automatically. The result of the calibration will be displayed in the app when completed.

After calibrating successfully, users can proceed with the operation.



If calibration fails, tap the notification to view and resolve the problem. Recalibrate once the problem is resolved.

- During calibration, tap , then  to cancel. If the calibration is cancelled, the accuracy of the flow meter is based on the data before the calibration was started.

## Calibrating the Compass

- ⚠ • It is important to calibrate the compass. The calibration result affects the flight safety. The aircraft may malfunction if the compass is not calibrated.
- DO NOT calibrate the compass where there is a chance of strong magnetic interference. This includes areas where there are utility poles or walls with steel reinforcements.
- DO NOT carry ferromagnetic materials with you during calibration such as keys or mobile phones.
- After calibrating successfully, the compass may be abnormal when you place the aircraft on the ground. This may be because of underground magnetic interference underground. Move the aircraft to another location and try again.

Calibrate the compass when prompted by the app. It is recommended to calibrate the compass with an empty tank.

1. Tap , then , move the slider to the bottom, and select Sensor Calibration, then Compass Calibration. Tap Calibration in the compass calibration section.
2. Hold the aircraft horizontally and rotate it 360° around a vertical axis with the aircraft approximately 1.2 m above the ground. Calibration is completed when the app displays that calibration was successful.
3. If the app displays a tilted aircraft, it indicates that the horizontal calibration failed. Users should tilt the aircraft and rotate it horizontally. Calibration is completed when the app displays that calibration was successful. To reduce the number of rotations required, the aircraft should be tilted at least 45°.

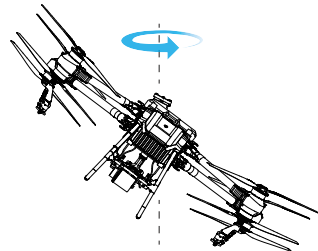
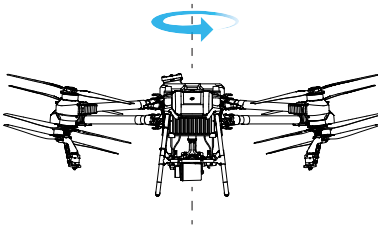

## Takeoff/Landing

The Combination Stick Command (CSC) listed below is used to start and stop the motors. Make sure you perform the CSC in one continuous motion. The motors begin to accelerate at an idle speed. Release both sticks simultaneously. Take off immediately once the motors are spinning, or else the aircraft may lose balance, drift, or even takeoff by itself and risk causing damage or injury.

### Takeoff

Push both sticks to the bottom inner or outer corners to start the motors.



### Landing

To land, pull down on the throttle stick to descend until the aircraft touches the ground. There are two methods to stop the motors.

Method 1: when the aircraft has landed, push and hold the throttle stick down. The motors will stop after three seconds.



Throttle Stick (left stick in Mode 2)

Method 2: when the aircraft has landed, push the throttle stick down, and perform the same CSC that was used to start the motors. Release both sticks once the motors have stopped.

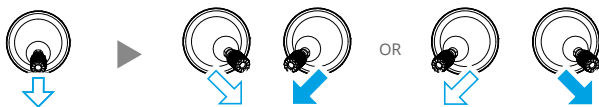





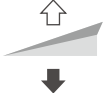

- ⚠ Spinning propellers can be dangerous. Stay away from spinning propellers and motors. DO NOT start the motors in confined spaces or where there are people nearby.
- Maintain control of the remote controller as long as the motors are running.
- DO NOT stop the motors mid-flight unless in an emergency situation where doing so will reduce the risk of damage or injury.
- It is recommended to use Method 1 to stop the motors. When using Method 2 to stop the motors, the aircraft may roll over if it is not completely grounded. Use Method 2 with caution.
- After landing, power off the aircraft before turning off the remote controller.

## Cruise / Maneuvering Flight

### Operating the Aircraft

This section explains how to control the orientation of the aircraft through the remote controller. Control can be set to Mode 1, Mode 2, or Mode 3. For example, the following description uses Mode 2:

Remote Controller (Mode 2)	Aircraft	Remarks
<p>Left Stick</p> 		<p><b>Throttle Stick:</b> Move the left stick vertically to control the elevation of the aircraft.</p> <p>Push up to ascend and push down to descend. Use the left stick to take off when the motors are spinning at an idle speed. The aircraft hovers in place if the stick is in the center position. The further the stick is pushed away from the center position, the faster the aircraft changes elevation.</p>
<p>Left Stick</p> 		<p><b>Yaw Stick:</b> Move the left stick horizontally to control the heading of the aircraft.</p> <p>Push left to rotate the aircraft counterclockwise and push right to rotate clockwise. The aircraft hovers in place if the stick is in the center position. The further the stick is pushed away from the center position, the faster the aircraft rotates.</p>
<p>Right Stick</p> 		<p><b>Pitch Stick:</b> Move the right stick vertically to control the pitch of the aircraft.</p> <p>Push up to fly forwards and press down to fly backwards. The aircraft hovers in place if the stick is in the center position. Push the stick further for a larger pitch angle and faster flight.</p>
<p>Right Stick</p> 		<p><b>Roll Stick:</b> Move the right control stick horizontally to control the roll of the aircraft.</p> <p>Push the stick left to fly left and right to fly right. The aircraft hovers in place if the stick is in the central position. Push the stick further for a larger roll angle and faster flight.</p>

## Flight Modes

The aircraft will fly in N-mode (Normal) by default. Users can switch between flight modes by toggling the Flight Mode switch on the remote controller when A-mode is enabled in the app.

**N-mode/F-mode (Normal):** The aircraft utilizes GNSS or the RTK module for positioning. When the GNSS signal is strong, the aircraft uses GNSS for positioning. When the RTK module is enabled and the differential data transmission is strong, it provides centimeter-level positioning. It will revert to A-mode when the GNSS signal is weak or when the compass experiences interference.

**S-mode (mapped to A-mode, Attitude):** GNSS is not used for positioning and the aircraft can only maintain altitude using the barometer. The flight speed in A-mode depends on its surroundings such as the wind speed.

### Attitude Mode Warning

In A-mode, the aircraft cannot position itself and is easily affected by its surroundings, which may result in horizontal shifting. Use the remote controller to position the aircraft.

Maneuvering the aircraft in A-mode can be difficult. Avoid flying in confined spaces or in areas where the GNSS signal is weak. Otherwise, the aircraft will enter A-mode, leading to potential flight risks. Land the aircraft in a safe place as soon as possible.

## Mapping Operation Modes

After the boundary points of the task area have been added, the app will automatically produce a task route. The aircraft will perform the mapping operation along the route and take photos for the mapping task area. The app will reconstruct an HD map using the photos after the flight so that users can plan a field on the HD map.

### Operation Procedure

The instructions below use Route Mapping as an example. In Operation View, tap the mode switch button on the upper left and select Route Mapping, then tap Add on the right of the screen.



1. Select Area Route or Boundary Route.

In Area Route, mapping and reconstruction will be performed for the whole task area. After reconstruction is completed, tap Identify Field to identify the boundary of the fields as well as obstacles. In Boundary Route, mapping and reconstruction will be performed only for the boundary of the task area, which takes a shorter time and is suitable for an obstacle-free area.

2. Select Resolution.

3. Tap to select the mode for adding points.



Crosshair is set by default. Drag the map and tap Add to add a point at the crosshairs. If Add Point with RC or Add Point with Aircraft is selected, walk with the remote controller to the desired position or fly the aircraft to the desired position and tap Add.

4. Edit boundary points.



Tap the added boundary point to select it and then drag to move the point. Tap the point twice to delete.

5. Adjust the route direction.

The automatically generated route is parallel to the longer side of the mapping area. Users can adjust the route direction by the following methods.

a. Drag  to adjust the flight direction of the planned route. Tap  to show the Fine Tuning menu and adjust.

b. Tap one of the boundaries to select it and then tap it twice to align the route direction with the selected boundary.

Tap  to save and name the mapping area. Tap  and move the slider to launch the aircraft. The aircraft will fly automatically along the route to perform the mapping task and land after the task is completed. Check the progress on the upper right side of the screen in the app. Wait for the reconstruction to complete. The reconstructed map will be displayed on the original map.



- If the mapping operation is paused or stopped during flight and a new mapping field is added, users can only view the paused or stopped operation in the operation list, and the operation cannot be resumed.
- If the user exits a mapping operation during reconstruction, select the operation in the operation list and tap  to restart reconstruction.
- The steps for Fruit Tree Mapping are the same as the steps for Route Mapping (Area/Boundary Route and Resolution settings are not necessary).

## Reconstruction Result Application

### Field Identifying

1. After reconstruction is completed, tap Identify Field. The app will identify and mark the boundary of fields as well as obstacles.
2. When adjustment for the boundary of a field is required, tap to select the field and tap Boundary Tuning to edit the boundary points, such as adjusting point position and adding points. The operations are the same as editing a field in Route operation mode. Tap Confirm after edit.





3. Adjust boundary for other fields if necessary.
4. If the identification results meet the corresponding operation scenarios, select one or multiple fields and tap Save to save the fields to the field list in Route operations. Users can easily use the fields in the Route operation mode.

## Route Planning

After reconstruction, tap Route Planning to plan a field on the HD map. The steps are the same as planning a field in Route operation mode. Users can also tap  to cancel the current selection and start a new mapping operation. The following explains the steps of route planning for Fruit Tree Mapping.

1. After reconstruction is completed, tap Route Planning.
2. Tap Add, and then select Predefined Route or Custom Route.
3. Drag the map and tap Add to add a point at the position of the crosshairs. The flight route will be generated automatically in the planned field after adding points in Predefined Route mode, which is suitable for evenly planted orchards. In Custom Route mode, tap the map to add points that follow the arrangement of the fruit trees, and the flight route will then contain those added points. This mode is suitable for orchards with unevenly distributed trees where a custom flight route is required.
4. Tap Confirm to save the planned field. Select the field in the plan list to adjust the route and set parameters. Users can also select the field and edit it in Fruit Tree operation mode.

## Result Uploading

Upload the mapping results to the cloud to bind them to a personal account. Users can log in the account on another remote controller and download the HD map from the cloud. Tap  in Operation View, and set HD Second-layer Map to Personal Account Map. Tap  in Home Page and then select Reconstruction Output in the dropdown menu on top of the screen. Tap  on the upper right, and select the desired reconstruction output files to upload.  will show on the upper right of the corresponding reconstruction output file after upload is completed.

## Spraying Operation Modes



Spraying operation modes include Route, Manual, and Fruit Tree operation modes. Use the mode switch button in the app to switch between modes. Select the desired mode for spray according to the operation scenarios.

## Route Operation

In Route operation mode, after planning a field, adding obstacles, and setting parameters, the app will intelligently produce a task route based on the input of the user. Apply and start an operation and the aircraft will fly along the task route automatically. Once prescription maps are added after an operation is applied, the aircraft will perform variable rate fertilization according to the information included in the maps. When selecting A-B Route operation mode, the aircraft travels along a pre-planned route. The aircraft supports connection routing and operation resumption, as well as the altitude stabilization and obstacle avoidance functions of the binocular vision system and phased array radars. Use the app to adjust the spray amount and flight speed. Route operation mode is recommended for large spray areas.

## Downloading Prescription Maps

Download prescription maps first in order to perform variable rate fertilization. <sup>[1]</sup>

1. Go to the home screen in the DJI Agras app and tap  to enter the task management screen.
2. Select Prescription Map in the dropdown menu and tap  on the right side. Select prescription map files in the pop-up window to download.
3. Downloaded prescription maps are displayed in the Prescription Map tag.

Users can also store prescription tasks planned in DJI Terra or downloaded from DJI SmartFarm on a microSD card, and then insert the microSD card into the remote controller to import the tasks to the app.



[1] Use DJI SmartFarm with the required firmware version to download prescription maps in DJI Agras. Please update the firmware to the required version.

## Planning Field

Go to Operation View in the app, tap the mode switch button on the upper left side, and select Route in the task mode selection screen. Tap  on the right side of the screen to select Field or A-B operation type, then tap Add. The instructions below use Field as an example.



1. Select the mode for adding points and the type of points to be added.  
 Select the point type to Fields and Crosshair will be set by default. Drag the map, and tap Add to add a point at the position of the crosshairs. If Add Point with RC or Add Point with Aircraft is selected, walk with the remote controller to the desired position or fly the aircraft to the desired position and tap Add.  
 Tap the point to select and drag to adjust its position. Tap the point twice to delete.

- A more accurate map is required to add points using the crosshairs. It is recommended to use the HD map reconstructed in a Mapping operation or select a map source in HD Second-layer Map in  under  to improve the accuracy of the added points.



- If the RTK dongle is mounted to the remote controller for adding points, make sure that RTK positioning is enabled. Go to , tap RTK to select the RTK signal source, and complete configuration. Wait until the system status bar on the upper left of the screen turns green, indicating that RTK positioning is being used.
- 

2. Mark obstacles and non-spraying areas.

- a. Select Obstacle as the type of point, drag the map, and tap Add to add a point at the crosshairs. The obstacle will then be marked.
- b. Select Round as the type of point. A red circle will appear on the map. Tap the center of the circle to select the obstacle and drag to adjust its position. Select the red point on the edge of the circle and drag to adjust the radius.
- c. Select Non-Spraying Area as the type of point, and then drag the map to add boundary points around areas that do not need to be sprayed, such as clearings and ditches.

3. Set the route parameters.

The app produces a task route automatically after the field is applied. The green point on the route indicates the start point while the yellow point indicates the end point. The route settings are as follows.

- a. Drag  near the route to adjust the flight direction of the planned route. Tap  to show the Fine Tuning menu and adjust the route manually. Tap one of the boundaries to select it and then tap it twice to align the route direction with the selected boundary.
  - b. Route Spacing: Set the distance between two neighboring routes.
- 



- If Auto Route Spacing Adjustment is enabled in Advanced Settings under Aircraft Settings, fine tuning is applied automatically after users adjust the value of the spacing. This will make the route more suitable for the task area.
- 

- c. Widen Field Margins: Adjust the distance between the boundaries and the routes near the field boundaries. Tap to select a boundary and adjust the distance between the routes and the selected boundary.
- d. Obstacle Boundary Safety Distance: Adjust the distance between the obstacle boundary and the route to prevent the aircraft from getting too close to the obstacle.
- e. Start Point: Tap Set to the right of Start Point, select a boundary point and tap Save. The start point of the route will change to a location close to the selected boundary point.
- f. Advanced Settings: Coverage Area, Course Angle, Route Segmentation and Low Speed Ascent can be set in Advanced Settings.

Coverage Area: If Route & Boundary is selected, the aircraft will fly and spray around the boundary of the field after reaching the endpoint.



Course Angle: When Auto Optimization is enabled, the app will automatically generate the optimal flight route. Users can also adjust the course angle manually.

Route Segmentation: Tap Set to open Route Segmentation. Tap and drag the sliders at the bottom to adjust the position of the start point (green) and end point (yellow) to segment the route.





Low Speed Ascent: When enabled, the aircraft will ascend to the preset height with a low speed to avoid damaging vegetation.

4. Tap , name the field, and save. The newly added field will be displayed in the field list.

## Editing Field

Select a field in the field list and tap  to enter Edit mode. The editing steps are the same as for field planning. Tap Divide Field and add anchor points to divide the selected field into several fields and set parameters separately. Tap  to save.

## Performing an Operation

1. Place the aircraft on open, flat ground with the rear of the aircraft facing you. Power on the remote controller and then the aircraft.
2. Go to Operation View, tap the mode switch button on the upper left side of the screen and select Route. Tap  on the left side to select a field from the field list. Tap  to apply the field.
3. Set parameters in the Task Settings on the left side of the screen. Users can set the spray amount, spray droplet size, flight speed, height above crops, and route spacing. Tap to open the dropdown menu at the top of the settings panel and select New Template. The current parameter configurations can be saved as a template for repeat operations.
4. Adjust the route:
  - a. If the location of the planned field is different from the actual field, tap Rectify Offset and adjust the field position using the fine tuning buttons.
  - b. Drag the map and tap Add on the right side of the screen to add a connection point at the crosshairs. Connection points and Connection Routing can be used to adjust the connection route to circumvent obstacles that were not marked during field planning.
5. Add prescription map: Tap  and select a prescription map from the list for a preview. Each area of the field on the map will be displayed in a color that corresponds to the quantity of material to be sprayed or spread. Tap OK to apply the selected prescription map to the field.
6. Tap , then check the aircraft status and task settings, set an appropriate Connection Routing/RTH Altitude, and move the slider to launch the aircraft. The aircraft will perform the operation automatically.



- The Connection Routing and RTH altitude and speed can be adjusted under Pre-Task Auto Check and Aircraft Settings. If it is adjusted in one location, it will automatically be updated in the other location too.
- Users can enable or disable Connection Route Altitude in Pre-Task Auto Check or Aircraft Settings. When enabled, the aircraft will fly to the first waypoint at the pre-set Connection Route altitude and return to the flight route with this altitude after the operation is paused and resumed. When disabled, the aircraft will arrive at the first waypoint with the pre-set height above the vegetation.

- ⚠️ • Only take off in open areas and set an appropriate auto-takeoff height according to the operating environment.
  - The operation is automatically cancelled if the motors are started before beginning the operation. You will need to recall the operation in the task list.
  - Once started, the aircraft flies to the starting point of the route and locks its heading in the direction of the first turning point for the duration of the flight route. During operation, users cannot control the aircraft heading via the control stick.
  - The aircraft does not spray while flying along route spacing and non-spraying area, but automatically sprays while flying along the rest of the route. Users can adjust the spray amount, flying speed, and the height above vegetation in the app.
  - An operation can be paused by moving the control stick slightly. The aircraft will hover and record the breakpoint, and then the aircraft can be controlled manually. To continue the operation, select it again from the Executing tag in the field list, and the aircraft will return to the breakpoint automatically and resume the operation. Pay attention to aircraft safety when returning to a breakpoint.
  - Users can set the action the aircraft will perform after the operation is completed in the app.
- 

## Connection Routing

---

- 📖 **Connection Routing:** refers to the procedure where the aircraft flies from the current position to the task route. Only available in Route (field).
- 

Connection Routing returns the aircraft from its current position to the task route and automatically avoids any obstacles that were marked outside of the task area during field planning. Users can add connection points, which the aircraft must fly through on the connection route to circumvent the obstacles that were not marked during field planning.

1. It is recommended to mark all obstacles inside or outside of the task area during field planning. After entering or resuming an operation, the connection route calculated by Connection Routing will be displayed on the map automatically.
2. Drag the map to align the crosshair to the desired position and tap Connection Point to add a connection point in the crosshair position.
3. Perform an operation, and the aircraft flies along the connection route including through any connection points that have been marked along the way.

## A-B Route

In A-B Route operation mode, the aircraft travels along a pre-planned route. Operation resumption and data protection are available, as well as the altitude stabilization and obstacle avoidance functions of the binocular vision system and phased array radars. Use the app to adjust the flying speed and spray amount. A-B Route operation mode is recommended for large, triangular, or rectangular spray areas.

## Operation Route

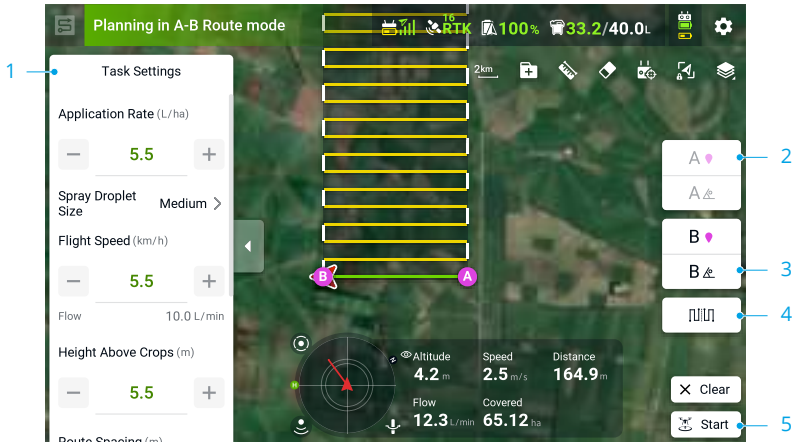

### 1. Set Operation Parameters

In the Task Settings on the left side of the screen, users can set the spray amount, spray droplet size, flight speed, height above crops, and route spacing.

### 2. Record Points A and B

Fly the aircraft to the starting point, depicted as Point A or B, hover, and tap Point A or B onscreen or press the preset customizable button on the remote controller. Point A or B will appear on the map after it is recorded. If the heading for Point A or B needs to be adjusted, the heading for Point A should be adjusted after Point A is recorded. Similarly, users should record Point B and then adjust the heading for Point B.

- ⚠️ • The aircraft sprays automatically when flying from Point A to Point B.
- Make sure to record Point A before Point B, and that the distance between Point A and B is more than 1 m.
- Points A and B cannot be recorded if the spray tank is empty or the flying speed of the aircraft is higher than 0.4 m/s.
- Users cannot adjust the position of Point A or B after they have been recorded. Start a new A-B Route operation if adjustment of Point A or B is required.
- For optimal performance, it is recommended to keep the direction of Point A to B parallel to one side of the polygonal spray area.

### 3. Adjust the angle for Point A and B

After Point A or B is recorded, tap the button for Point A/B heading onscreen, and move the yaw stick on the remote controller. The heading of the aircraft corresponds to the heading for Point A or B, which is indicated by a dotted line on the screen. Tap the button again to set the current heading for Point A or B.

- ⚠️ • The heading for Point A or B cannot be set when the rotating speed of the aircraft's heading is higher than 15°/s.



- During the operation, the aircraft will only spray liquid while flying along the route parallel to the line from A to B, and does not spray liquid while flying along the other parts of the route.



## Manual Operation

This mode is ideal for small or irregularly-shaped operating areas. In the task mode selection screen, select M to enter Manual operation mode. In the Task Settings on the left side of the screen, users can select Manual or Manual Plus mode.

### Manual Mode

Users can set the spray amount, spray droplet size, height above crops and limit the maximum flight speed. In this mode, users can control every movement of the aircraft, spray liquid via the spray button on the remote controller, and adjust the spray rate via the dial. Refer to Controlling the Spraying System for more information.

### Manual Plus Mode

Users can set the spray amount, spray droplet size, height above crops, flight speed and route spacing. Tap  or  onscreen, and the aircraft will fly to the left or right at the preset distance for route spacing. The aircraft automatically sprays when accelerating forward, backward, or diagonally, but does not spray when flying sideways.



- After the additional sprinklers are mounted and Full Mode is enabled in the app, the aircraft will spray using the rear sprinklers when flying forward and the front sprinklers when flying backward.





- Under optimal working conditions, and if the altitude stabilization function is enabled, the radar module maintains the distance between the aircraft and vegetation when spraying.
- The heading of the aircraft will be locked after Course Lock is enabled. Users can control all other movements but not the forward direction of the aircraft.
- During an operation, users can adjust the spray amount, flight speed, and height above vegetation but not the route spacing.

## Fruit Tree Operation

This mode is suitable for sloped terrain with mountain crops or fruit trees. Users can plan a field on the reconstructed HD map in the app or plan a field in DJI SmartFarm or DJI Terra. Users can obtain their plans for Fruit Tree operations by either downloading them from DJI SmartFarm or importing them from a microSD card and then perform the operation in Fruit Tree operation mode.

### Downloading/Importing Fruit Tree Operations Information

1. Download from DJI SmartFarm: Go to the home screen in the DJI Agras app and tap  to enter the task management screen. Tap , and select desired Fruit Tree operations in the pop-up window and download.

2. Import from the microSD card: Insert the microSD card with the planning data from DJI Terra into the microSD card slot on the remote controller. Next, go to the home screen of DJI Agras. Select the data in the pop-up window and import it. To view the data, go to Task Management on the home screen.
3. The downloaded or imported operations will be displayed in the operation list in Fruit Tree operation mode.

## Editing Field

Go to Operation View, tap the mode switch button and select Fruit Tree on the task mode selection screen. Tap ► on the left side and select the operation in the field list, and tap Edit to edit the operation planned on the reconstructed map.

- ☀️ • Fruit tree operations imported from DJI SmartFarm or microSD card can only be edited via Route Segmentation in the app.



### 1. Modify Result

Tap AI on the upper right and then tap Modify Result on the right to modify the inaccurately identified results manually. Drag the map and tap Add to add a tree crown point at the crosshairs. Tap the point twice to delete it. Choose the type of point at the bottom of the screen and add boundary points to mark the area as a building, pole, water, or something else.

### 2. Adjust Waypoint Altitude

Tap the waypoint to select and adjust the altitude of the selected point. Adjusting the altitude of multiple points at once is supported.

### 3. Switch to 3D View

Tap the 3D button and check the relative height of the route to the ground as well as to the height of surrounding objects in 3D view. Tap Edit Waypoint and then tap the 3D button. The altitude of the waypoints can be adjusted more precisely in 3D view.

4. Edit the Route

Tap Edit and enter the view shown in the figure below. Users can adjust the boundary points and flight route.

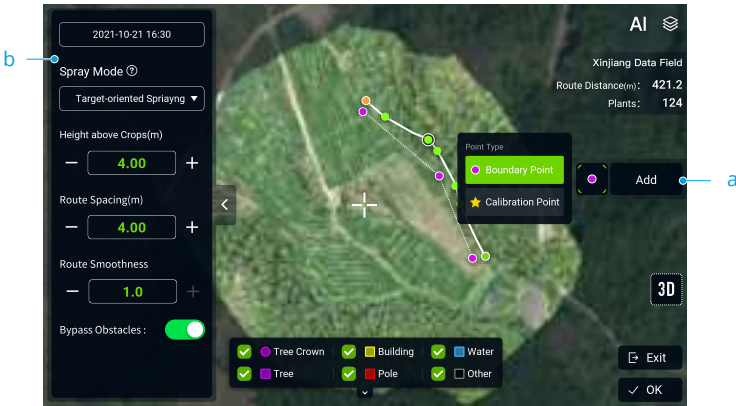

a. Add Points

Tap and select the type of point, then drag the map and tap Add to add a boundary point or calibration point at the crosshairs.

b. Set the Route Parameters

The app produces a task route automatically after the field is applied. The green point on the route indicates the start point, while the yellow point indicates the end point. The route settings are as follows.

Adjust the route direction: Drag near the route to adjust the flight direction of the planned route. Tap to show the Fine Tuning menu and adjust as needed.

Spray mode: The spraying modes for fruit tree operation are as follows: Standard Spraying, Fixed Spot Spraying, or Target-oriented Spraying. Six spraying methods are available for different fruit tree operation scenarios when combined with different Flight Route Plan Types.

Spray Modes	Predefined Route	Custom Route
Standard Spraying	After adding boundary points around the field, a zig-zag route will be generated automatically with the same route spacing in the field. The aircraft will spray continuously following the route but not spray in the areas where there are no trees.	Tap on the map to add waypoints along the fruit trees, and then the generated flight route will contain those waypoints. The aircraft will spray continuously following the route but skip the areas where there are no trees.

Fixed Spot Spraying	After adding boundary points around the field, a flight route including all the tree crown centers will be generated automatically. The aircraft will only spray pesticide after positioning itself above the tree crown center.	Tap on the map to add waypoints along the fruit trees. The app will generate a flight route that connects all the tree crown centers within 1.5 m of the waypoints. The aircraft will only spray pesticide after positioning itself above the tree crown centers.
Target-oriented Spraying	After adding boundary points around the field, a flight route including all the tree crown centers will be generated automatically. The aircraft will spray continuously following the route but skip the areas where there are no trees.	Tap on the map to add waypoints along the fruit trees. The app will adjust the waypoints according to the location of the tree crown centers and generate a flight route. The aircraft will spray continuously following the route but skip the areas where there are no trees.

Height Above Crops: Set the height of the aircraft relative to the crops below during the operation.

Route Spacing: Adjust the route spacing of the standard spraying operations generated using Predefined Route mode.

Route Smoothness: A higher value means lower terrain following accuracy, but more stable flight.

Bypass Obstacles: When enabled, the aircraft will adjust the flight route to bypass the marked obstacles.

## Performing an Operation

1. Place the aircraft on open, flat ground with the rear of the aircraft facing you. Power on the remote controller and then power on the aircraft.
2. Go to Operation View, tap the mode switch button on the upper left side of the screen and select Fruit Tree. Tap ► on the left side to select a field from the field list. Tap  to apply the field.
3. Set parameters in the Task Settings on the left side of the screen. Users can set the spray amount, spray droplet size, flight speed, and the height above crops. Rotary Spraying can be enabled for operations involving tree crown center points. The aircraft will rotate automatically and spray the pesticide after positioning itself above a tree crown center when enabled.
4. Adjust the route:
  - a. Tap Rectify Offset and adjust the route position using the Fine Tuning buttons. If calibration points are included in the route, place the aircraft at one of the calibration points and tap Rectify Aircraft Position.
  - b. Drag the map and tap Connection Point on the right to add a connection point at the crosshairs. Connection points and Connection Routing can be used to adjust the connection route to circumvent obstacles that were not marked during field planning.

5. Tap  check the aircraft status and task settings, set an appropriate Connection Routing/RTH Altitude, and move the slider to launch the aircraft. The aircraft will perform the operation automatically.

-  • The Connection Routing and RTH altitude and speed can be adjusted under Pre-Task Auto Check and Aircraft Settings. If it is adjusted in one location, it will automatically be updated in the other location too.
- Users can enable or disable Connection Route Altitude in Pre-Task Auto Check or Aircraft Settings. When enabled, the aircraft will fly to the first waypoint at the pre-set Connection Route altitude and return to the flight route with this altitude after the operation is paused and resumed. When disabled, the aircraft will arrive at the first waypoint with the pre-set height above the vegetation.

-  • Only take off in open areas and set an appropriate auto-takeoff height according to the operating environment.
- The operation is automatically cancelled if the motors are started before beginning the operation. You will need to recall the operation in the task list.
- Once started, the aircraft flies to the starting point of the route and locks its heading in the direction of the first turning point for the duration of the flight route. During operation, users cannot control the aircraft heading via the control stick.
- Users can adjust the spray amount, flying speed, and the height above vegetation in the app.
- An operation can be paused by moving the control stick slightly. The aircraft will hover and record the breakpoint, and then the aircraft can be controlled manually. To continue the operation, select it again from the Executing tag in the field list, and the aircraft will return to the breakpoint automatically and resume the operation. Pay attention to aircraft safety when returning to a breakpoint.
- Users can set the action the aircraft will perform after the operation is completed in the app.

## System Shutdown

After landing, push the throttle stick down and hold to stop the motors. Press the power button and then press and hold to power off the aircraft and remote controller.

## Post-Flight Inspection

1. Make sure that the aircraft is powered off. Remove the battery from the aircraft and store it properly.
2. Check the aircraft structure, clean the dirt and dust, and replace any loose or damaged parts.
3. Make sure that there is no residue in the spray/spread tank and the whole spraying/spreading system.
4. Make sure that the aircraft is folded correctly for transportation.
5. Make sure that the battery connector on the aircraft is clean and dry.

# Emergency Procedures

## General Information

This chapter introduces how to handle the aircraft or remote controller if one of the following emergencies occurs.

## Engine Failure

If one or more motors fail during flight, the aircraft will calculate the remaining propulsion according to factors such as the status of the propulsion system, aircraft weight, and flight environment. Two possible scenarios may occur:

1. Remaining propulsion is sufficient: the aircraft will continue to fly in a stable condition with remaining propulsion.
2. Remaining propulsion is insufficient: the aircraft will spin and perform a controlled descent. Afterward, it is recommended that users land the aircraft manually and check and repair the aircraft immediately.

## Fire

A prompt will appear in the app and the flight controller will reduce the power of the aircraft when the flight battery temperature is too high. The battery will be locked for future use if it exceeds the temperature threshold during flight and cannot be used again after landing.

Follow the instructions below if the flight battery catches fire.

1. If the battery catches fire when the battery is being charged using a battery station or generator, make sure personal safety is guaranteed, power off the battery station or generator immediately, and disconnect the battery from the charging device. If the battery catches fire when the battery is in the aircraft, make sure personal safety is guaranteed and disconnect the battery from the aircraft immediately.
2. Transfer the flammable materials surrounding the battery to a safe distance of more than 5 m away.
3. If the fire is small, use materials such as large amount of sand to cover the location of the fire and pour cold water to cool the battery until there is no longer any smoke being produced. With the help of fire-resistant gloves or other protective tools that allow users to avoid direct contact with the battery, move the battery to a container with enough water to fully immerse the battery and add an appropriate amount of salt to help fully discharge the battery. Leave the container in a cool place for more than 72 hours and take out the battery and discard it.
4. If the fire is large, double check that there are no flammable materials surrounding the fire, extend the safety distance to more than 10 m, and evacuate any people in the surrounding environment. Wait until the battery burns out and the fire is extinguished in order to avoid any further accidents.

## Loss of C2 Link

The aircraft supports Failsafe RTH function.

 **Home Point:** The default home point is the first location where your aircraft received strong GNSS signals (when the GNSS icon is green).

**RTH:** RTH brings the aircraft back to the last recorded home point.

## Failsafe RTH

 • The aircraft will RTH or hover if the remote controller signal is lost. The action can be set in the app. Failsafe RTH will only be available if RTH is set.

Failsafe RTH is automatically activated if the remote controller signal is lost for more than three seconds, provided that the home point has been successfully recorded, the GNSS signal is strong (when the GNSS icon is green), and the RTK module is able to measure the heading of the aircraft. The RTH continues if the remote controller signal is recovered, and users can control the aircraft using the remote controller. Press the RTH button once to cancel RTH and regain control of the aircraft.

## RTH Illustration

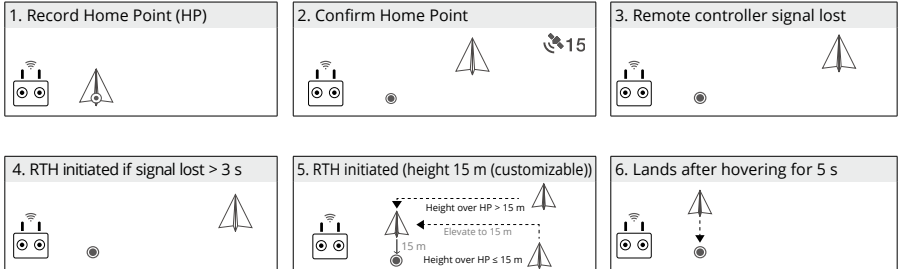

 • If RTH is triggered during Route operations, the aircraft can plan a flight path for RTH to circumvent the obstacles added when planning a field.

## RTH Safety Notices



The aircraft will not enter RTH if RTH is triggered when the aircraft is within a 3m radius of the Home Point, but the remote controller will still sound an alert. Exit RTH to cancel the alert.



The aircraft cannot return to the home point when the GNSS signal is weak (the GNSS icon displays red) or is unavailable.

## Obstacle Avoidance During RTH

In an optimal operating environment, obstacle avoidance during RTH is available. If there is an obstacle within 20 m of the aircraft, the aircraft decelerates and then stops and hovers. The aircraft will exit the RTH procedure and wait for further commands.

---



- If RTH is triggered during Route or Fruit Tree operations, the aircraft will calculate an RTH path that circumvents obstacles added while planning the task area.
  - If connection points were added before performing the operation, the aircraft will fly to the Home Point via the connection points. Connection points cannot be deleted during the operation. Adjust the connection points after tapping the End button.
  - Exit automatic RTH and control the aircraft to return to home manually if it is not necessary to fly through the connection points to return.
- 

## Landing Protection Function

Landing Protection activates during auto landing. The procedure is as follows:

1. After arriving at the home point, the aircraft descends to a position 3 m above the ground and hovers.
  2. Control the pitch and roll sticks to adjust the aircraft position and make sure the ground is suitable for landing.
  3. Pull down the throttle stick or follow the onscreen instructions in the app to land the aircraft.
- 



- When using fixed RTK positioning, the aircraft will land directly instead of entering Landing Protection. Landing Protection is still available if the aircraft is performing a fruit tree route operation planned using DJI Terra.
- 

## Loss of Navigation Systems

When using fixed RTK positioning, the aircraft will switch to GNSS if RTK is unavailable during flight. If GNSS is also unavailable, the aircraft will switch to Attitude (ATTI) mode automatically to stabilize its attitude and a prompt will appear in the app to remind users to fly with caution and land as soon as possible.

## Control Station Failures

Control station failures include the following scenarios.

1. Control signal is lost: the aircraft will enter Failsafe RTH if Failsafe RTH is enabled in the app. Refer to Loss of C2 Link for more information about Failsafe RTH. The aircraft action can also be set to hovering in place until the aircraft lands with critically low battery level or landing directly.

2. The app crashes during automatic operations while the control signal is normal: in this case, the C2 link between the aircraft and the remote controller is in good condition, so the aircraft will continue performing the current operation until landing is triggered by critically low battery level. Users can exit from Route operations by moving the control stick slightly and control the aircraft manually.

## Flyaway

The flight telemetry of the aircraft will be displayed on the screen of the remote controller during flight. If the aircraft flies away during operation, users can search for the aircraft according to the location of the aircraft and remote controller displayed on the map in the app. If the GNSS signal of the aircraft is lost after the aircraft flies away then the aircraft will not be displayed on the map in the app. Users can estimate the location of the aircraft to its last location, flight speed, and heading before the loss of the GNSS signal.

## Reporting Requirements

Users are responsible to inform DJI of any event of an uncontrolled crash or flyaway within 2 business days through DJI Support, a DJI authorized dealer, or other means and shall upload the flight data related to the event. See the instructions of flight data upload from

<https://youtu.be/X8sVce69z5g>

# Weight and Balance and Equipment List

Users can remove the spray tank and install the spreading system for spreading operations. The center of gravity is within the ranges listed in the Center of Gravity Limitations section whether a spray tank or spreading system is used.

## Handling, Servicing and Instructions for Maintenance and Continued Airworthiness

### Ground Handling

1. Make sure that the aircraft is powered off. Remove the battery from the aircraft and store it properly.
2. Check the aircraft structure, clean the dirt and dust, and replace any loose or damaged parts.
3. Clean the residue in the spray/spread tank and the spraying/spreading system and keep the system dry.
4. Make sure that the aircraft is folded correctly for transportation or storage.
5. Make sure that the battery connector on the aircraft is clean and dry.

### Disassembly, Storage, and Reassembly

The tank, propellers, and sprinklers on the aircraft can be disassembled. Follow the instructions below to disassemble, reassemble, and store them. Make sure to remove the Intelligent Flight Battery from the aircraft before disassembly and reassembly.

# Tank

## Disassembly

A.

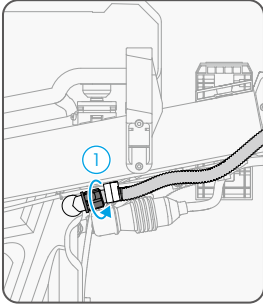

B.

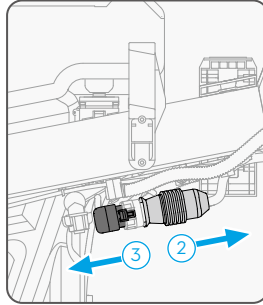

C.

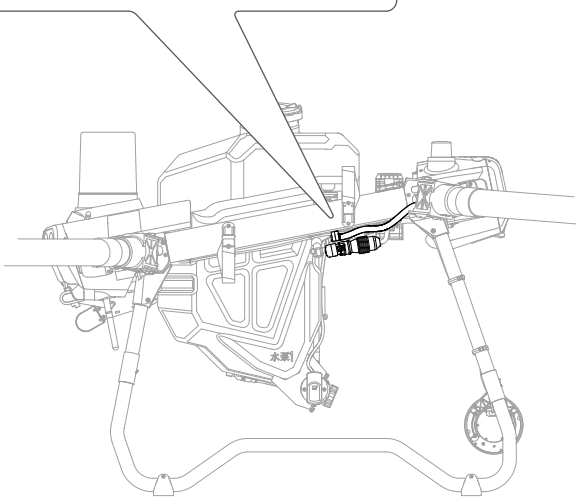
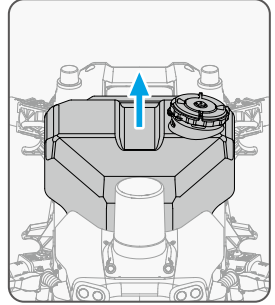

1. On the aircraft, locate the hoses on either side of the spray tank. Loosen the nut on the hose ① and detach the hose and nut. (Figure A)  
 Note: after the hose is removed, make sure to tighten the hose nut on the spray tank hose connector to avoid losing the nut.
2. Locate the spraying system cable in the rear of the left landing gear on the aircraft. Move the protective rubber on the cable ② and unplug the cable from the connector ③ . Operate with caution to avoid damaging the cable. (Figure B)
3. Lift and remove the spray tank on the aircraft. (Figure C)

## Reassembly

Follow the steps of disassembly in reverse order for reassembly.

## Propellers

### Disassembly

1. Remove the two M5×15 propeller blade screws using a proper hex key.
2. Remove the propeller adapter, the two washers above and under each propeller blade.

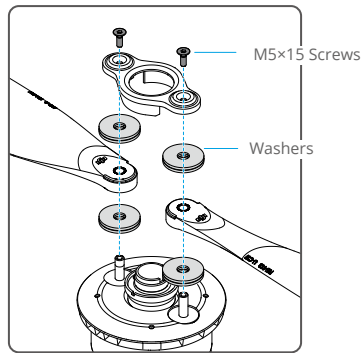

### Reassembly

Identify the CW or CCW marks on the propeller blades and motors. Make sure to assemble the parts with the same mark. T50 users can identify the upper (U) and lower (L) propeller blades with the corresponding letter at the end of the model number on each propeller.

1. Place the one washer onto one of the mounting hole on the motor. Place the propeller blade and then one washer.
2. Follow the same steps for the other mounting hole on the motor.
3. Place the propeller adapter on the top.
4. Insert the two M5×15 screws to the mounting holes and tighten to secure the propeller blades.

## Sprinklers

### Disassembly

1. Rotate and remove the screw and cover at the bottom of the sprinkler. Remove the centrifugal disk module.
2. Separate the upper and lower disks.
3. Remove the washer on the lower disk.

## Reassembly

Follow the steps of disassembly in reverse order for reassembly.

## Storage

### Aircraft Storage

1. Keep the aircraft and parts clean and dry and store them in a cool dry place. Recommended storage temperature (when the tank, flow meter, pumps, and hoses are empty): between -20° and 40° C (-4° and 104° F).
2. Make sure to keep the small parts properly to avoid loss. Small parts, such as cables and straps, are dangerous if swallowed. Keep all parts out of reach of children and animals.
3. Remove or empty the tank when not in use to avoid damaging the landing gear.
4. Remove the battery from the aircraft when stored.

### Battery Storage

Disconnect the battery from the aircraft and check if there is any buildup in the battery port.

- ⚠ • Power off and disconnect the battery from the aircraft or other devices during transportation.
  - Keep batteries out of the reach of children and animals. Seek professional medical support immediately if children swallow parts of the battery.
  - If the battery level is critically low, charge the battery to a power level of 25%. DO NOT store a battery with a low power level for an extended period. Otherwise, the performance will be negatively affected.
  - DO NOT leave the battery near heat sources such as a furnace or heater. DO NOT leave the battery inside a vehicle on hot days.
  - The battery must be stored in a dry environment.
  - DO NOT place the battery near explosive or hazardous material or near metal objects such as eyeglasses, watches, jewelry, and hairpins.
  - DO NOT attempt to transport a battery that is damaged or has more than 30% power. Discharge the battery to 25% or lower before transportation.
  - Make sure the battery is placed on a flat surface to avoid damage to the battery from sharp objects.
- 
- ① • If storing the battery for more than three months, it is recommended to store the battery in a battery safety bag in an environment at a temperature range from -20° to 40° C (-4° to 104° F).
  - DO NOT store the battery for an extended period after fully discharging. Doing so may over-discharge the battery and cause irreparable damage to the battery cell.
  - If a battery with a low power level has been stored for an extended period, the battery will be in deep hibernation mode. Charge to wake the battery.
  - Disconnect the battery from the aircraft if you intend to store the battery for an extended period.

## Charging / Conditioning / Replacing Batteries

### Charging Batteries

Using the C10000 Intelligent Charger to charge the batteries. C10000 Intelligent Charger supports both fast and slow charging. Different power cables are required to connect to qualified power supplies when using different charging methods.

#### Fast Charging

1. Turn off the air circuit breaker for the three-phase AC power supply.
2. Take out the safety pins from the fast charging cables, connect the cables to the charger, and insert the safety pins back in place.

---

⚠ • After connecting the fast charging cables to the charger, make sure to insert the safety pins back into place to avoid damage caused by a loose connector.

---

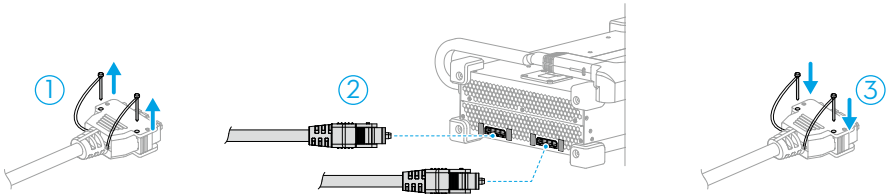

3. Connect the two fast charging cables to a three-phase-five-wire industrial power supply: Connect the hot wires (labeled L), neutral wires (labeled N), and ground wires (labeled PE) of the fast charging cables to the hot terminals, neutral terminal, and ground terminal of the three-phase power supply, respectively. Make sure to connect the two hot wires to different hot terminals.

---

⚠ • Only qualified electricians wearing insulated gloves can perform the fast charging connection.

- When using the fast charging connection, the input current required by the charger exceeds 16A. DO NOT connect the fast charging cables to 16A or 10A power outlets.

---

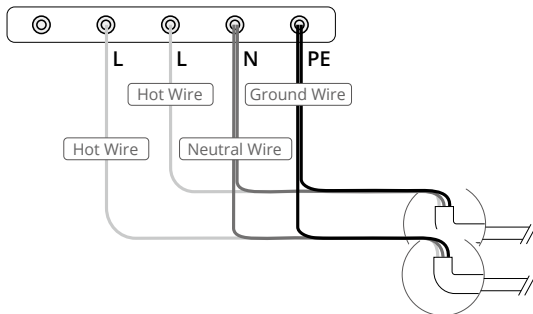

4. Turn on the air circuit breaker of the three-phase AC power supply.
5. Connect the charger to the battery. To charge the DB1560/T40 Intelligent Flight Battery, connect the charging cable to the air-cooled heat sink before putting the battery into the heat sink. The charger starts to charge the battery. The four LEDs of the battery blink in sequence while charging. Remove the battery when the four LEDs turn solid or off and put another battery inside the heat sink to charge.

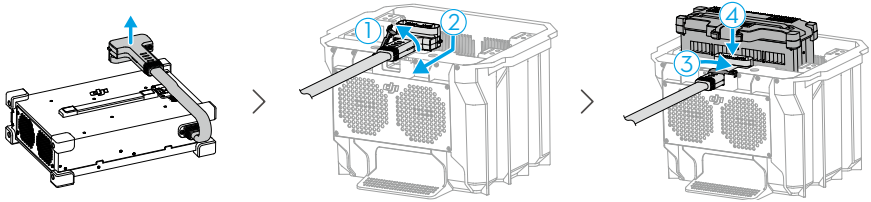

6. When charging is finished, turn off the air circuit breaker before disconnecting the fast charging cables from the charger.

## Slow Charging

- ⚠ • The type of the power outlet may vary depending on the country or region. Choose the appropriate power outlet accordingly.
- DO NOT use two slow charging cables simultaneously indoors.

1. Take out the safety pins from the conversion cable, connect the conversion cable to the main AC power port of the charger, and insert the safety pins back in place.

- ⚠ • After connecting the conversion cable to the charger, make sure to insert the safety pins back into place to avoid damage caused by a loose connector.

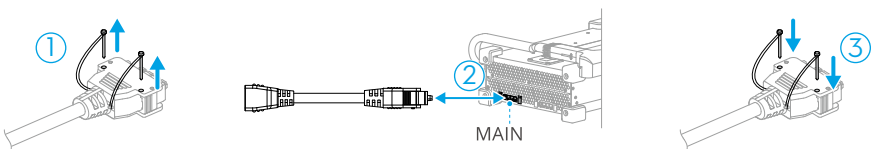

2. Connect the slow charging cable with the conversion cable, and then connect to a power outlet.

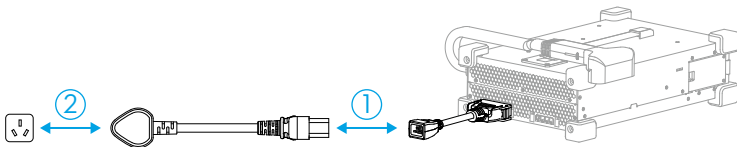

3. Connect the charger to the battery using the same method described in the Fast Charging section.
4. When charging is finished, disconnect the slow charging cable from the power outlet and then disconnect the conversion cable from the charger.

## Conditioning Batteries

- ⚠ • If the battery is not used for an extended period, the battery life may be reduced.
- Fully charge and discharge the battery at least once every three months to ensure the performance of the battery.
- If a battery has not been charged or discharged for five months or more, the battery will no longer be covered by the warranty.

## Replacing Batteries

The battery should not be used again if any accident occurs. Users should replace the battery immediately. See details below.

1. DO NOT use swollen, leaking, or damaged batteries.
2. DO NOT use a battery that has been dropped.
3. If the battery falls into water while inserted in an aircraft during flight, take it out immediately, and put it in a safe and open area. DO NOT use the battery again.
4. If the battery cannot be discharged completely, replace the battery and contact a professional battery recycle company for assistance on disposal.

## Maintenance Program

### Operator Performing List

1. Clean all parts of the aircraft at the end of each day of spraying after the aircraft returns to a normal temperature. DO NOT clean the aircraft immediately after operations are completed.
  - a. Fill the spray tank with clean water or soapy water and spray the water through the sprinklers until the tank is empty. Repeat the step two more times.
  - b. Remove the spray tank strainer and sprinklers to clean them and clear any blockage. Afterwards, immerse them in clean water for 12 hours.
  - c. Make sure that the aircraft structure is completely connected so that it can be washed directly with water. It is recommended to use a spray washer filled with water to clean the aircraft body and wipe with a soft brush or wet cloth before removing water residue with a dry cloth.
  - d. If there is dust or pesticide liquid on the motors, propellers, or heat sinks, wipe them with a wet cloth before cleaning the remaining water residue with a dry cloth.
  - e. Store the cleaned aircraft in a dry environment.
2. Wipe the surface and screen of the remote controller with a clean wet cloth that has been wrung out with water daily after operations.
3. Inspect the aircraft every 100 flights or after flying for over 20 hours:
  - a. Check for and replace worn propellers.
  - b. Check for loose propellers. Replace propellers and propeller washers if needed.
  - c. Check for aging plastic or rubber parts.

- d. Check for poor atomization of the sprinklers. Clean the centrifugal disks of the sprinklers thoroughly. Replace the centrifugal disks in the case of severely poor atomization.
- e. Replace the spray tank strainer.
4. Keep the protective cover of the radar module clean. Clean the surface with a soft damp cloth and air dry before using again.
5. Regularly wipe off dirt on the gimbal of the FPV camera. Keep the FPV camera and the cameras of the binocular vision system clean. Make sure that the aircraft is powered off. First remove any larger pieces of grit or sand then wipe the lens with a clean, soft cloth to remove dust or other dirt.

## Notice

1. In the event of a crash or collision, make sure to thoroughly inspect every part of the aircraft and make any necessary repairs and replacements before your next flight. If you have any problems or questions, contact DJI Support or a DJI authorized dealer.
2. DO NOT attempt to repair the aircraft if any parts are damaged. Contact DJI Support or a DJI authorized dealer for professional maintenance services. The T50/T25 Drone Recommended Maintenance Cycle table in the Supplements section lists the recommended maintenance cycle and item maintenance performed by DJI authorized dealers only.
3. When a replacement part is required, make sure to purchase the new part from a DJI authorized dealer only.

Find the dealer information from <https://www.dji.com/where-to-buy/agriculture-dealers>

# Supplements

This chapter introduces the specifications of the whole system, additional functions of the aircraft, the operation of optional equipment, and other relevant information.

## Specifications

### T50

Aircraft	
Model	3WWDZ-40B
Weight	39.9 kg (excl. battery) 52 kg (inc. battery)
Max Takeoff Weight <sup>(1)</sup>	Max takeoff weight for spraying: 92 kg (at sea level) Max takeoff weight for spreading: 103 kg (at sea level)
Max Diagonal Wheelbase	2200 mm
Dimensions	2800×3085×820 mm (arms and propellers unfolded) 1590×1900×820 mm (arms unfolded and propellers folded) 1150×750×900 mm (arms and propellers folded)
Hovering Accuracy Range (with strong GNSS signal)	D-RTK enabled: Horizontal: ±10 cm, Vertical: ±10 cm D-RTK disabled: Horizontal: ±60 cm, Vertical: ±30 cm (radar module enabled: ±10 cm)
Operating Frequency <sup>(2)</sup>	2.4000-2.4835 GHz, 5.725-5.850 GHz
Transmitter Power (EIRP)	2.4 GHz: <20 dBm (SRRC/CE/MIC), <33 dBm (FCC) 5.8 GHz: <33 dBm (SRRC/FCC), <14 dBm (CE)
RTK/GNSS Operating Frequency	RTK: GPS L1/L2, GLONASS F1/F2, BeiDou B1I/B2I/B3I, Galileo E1/E5b, QZSS L1/L2 GNSS: GPS L1, GLONASS F1, Galileo E1, BeiDou B1I, QZSS L1
Hovering Time <sup>(3)</sup>	No payload for spraying: 16.5 min (takeoff weight of 52 kg with a 30Ah battery) Fully loaded for spraying: 7 min (takeoff weight of 92 kg with a 30Ah battery) No payload for spreading: 15 min (takeoff weight of 53 kg with a 30Ah battery) Fully loaded for spreading: 5.5 min (takeoff weight of 103 kg with a 30Ah battery)
Max Configurable Flight Radius	2000 m
Max Wind Resistance	6 m/s
Operating Temperature	0° to 45° C (32° to 113° F)
Propulsion System	
Motors	
Stator Size	100×33 mm
KV	48 rpm/V
Power	4000 W/rotor

**Propellers**

Diameter	54 in (1371.6 mm)
Rotors Quantity	8

**Dual Atomizing Spraying System**

**Spray Tank**

Volume	40 L
Operating Payload <sup>[1]</sup>	40 kg

**Sprinklers**

Model	LX8060SZ
Quantity	2
Droplet Size	50-500 µm
Max Effective Spray Width <sup>[4]</sup>	4-11 m (at a height of 3 m above the crops)

**Delivery Pumps**

Type	Magnetic drive impeller pump
Max Flow Rate	16 L/min (2 sprinklers) 24 L/min (4 sprinklers)

**Phased Array Radar System**

Model	RD241608RF (forward phased array radar) RD241608RB (rear phased array radar)
Terrain Follow	Max slope in Mountain mode: 50° Altitude detection range: 1-50 m Stabilization working range: 1.5-30 m
Obstacle Avoidance <sup>[5]</sup>	Obstacle sensing range (omnidirectional): 1-50 m FOV: Forward phased array radar: horizontal 360°, vertical ±45°, upward ±45° (cone) Rear phased array radar: vertical 360°, horizontal ±45°
	Working conditions: flying higher than 1.5 m over the obstacle at a horizontal speed no more than 10 m/s and vertical speed no more than 3 m/s. Safety limit distance: 2.5 m (distance between the front of propellers and the obstacle after braking) Sensing direction: multidirectional obstacle sensing
Operating Frequency	24.05-24.25 GHz (NCC/FCC/MIC/KCC/CE)
Power Consumption	23 W (forward phased array radar) 18 W (rear phased array radar)
Transmitter Power (EIRP)	<20 dBm (NCC/FCC/MIC/KCC/CE)
Operating Voltage	DC 15V
Operating Temperature	0° to 45° C (32° to 113° F)
<b>Binocular Vision System</b>	
Measurement Range	0.5-29 m
Effective Sensing Speed	≤10 m/s

FOV	Horizontal: 90°, Vertical: 106°
Operating Environment	Adequate light and discernible surroundings
<b>Remote Controller</b>	
Model	RM700B
GNSS	GPS + Galileo + BeiDou
Screen	7.02-in LCD touchscreen, with a resolution of 1920×1200 pixels, and high brightness of 1200 cd/m <sup>2</sup>
Operating Temperature	-20° to 50° C (-4° to 122° F)
Storage Temperature Range	Less than one month: -30° to 45° C (-22° to 113° F) One to three months: -30° to 35° C (-22° to 95° F) Three months to one year: -30° to 30° C (-22° to 86° F)
Charging Temperature	5° to 40° C (41° to 104° F)
Internal Battery Chemical System	LiNiCoAlO <sub>2</sub>
Internal Battery Runtime	3 hours 18 minutes
External Battery Runtime	2 hours 42 minutes
Charging Type	It is recommended to use a locally certified USB-C charger at a maximum rated power of 65 W and maximum voltage of 20 V such as the DJI 65W Portable Charger.
Charging Time	2 hours for internal battery or internal and external battery (when remote controller is powered off and using a standard DJI charger)
<b>O3 Agrass</b>	
Operating Frequency <sup>(2)</sup>	2.4000-2.4835 GHz, 5.725-5.850 GHz
Transmitter Power (EIRP)	2.4 GHz: <33 dBm (FCC), <20 dBm (CE/SRRC/MIC) 5.8 GHz: <33 dBm (FCC), <14 dBm (CE), <23 dBm (SRRC)
Max Transmission Distance	7 km (FCC), 5 km (SRRC), 4 km (MIC/CE) (unobstructed, free of interference, and at an altitude of 2.5 m)
<b>Wi-Fi</b>	
Protocol	Wi-Fi 6
Operating Frequency <sup>(2)</sup>	2.4000-2.4835 GHz, 5.150-5.250 GHz, 5.725-5.850 GHz
Transmitter Power (EIRP)	2.4 GHz: <26 dBm (FCC), <20 dBm (CE/SRRC/MIC) 5.1 GHz: <26 dBm (FCC), <23 dBm (CE/SRRC/MIC) 5.8 GHz: <26 dBm (FCC/SRRC), <14 dBm (CE)
<b>Bluetooth</b>	
Protocol	Bluetooth 5.1
Operating Frequency	2.4000-2.4835 GHz
Transmitter Power (EIRP)	<10 dBm

- [1] The DJI Agras app will intelligently recommend the payload weight limit for the tank according to the current status and surroundings of the aircraft. Do not exceed the recommended payload weight limit when adding material to the tank. Otherwise, the flight safety may be affected.
- [2] 5.8 and 5.1 GHz frequencies are prohibited in some countries. In some countries, the 5.1 GHz frequency is only allowed for use indoors.
- [3] Hovering time acquired at sea level with wind speed lower than 3 m/s and a temperature of 25° C (77° F). For reference only. The data may vary depending on the environment. Actual results shall be as tested.
- [4] The spray width depends on the actual operation scenarios.
- [5] The effective sensing range varies depending on the material, position, shape, and other properties of the obstacle. The downward sensing function is used to assist in Terrain Follow, while the sensing function on the other sides is for obstacle sensing.

## T25

Aircraft	
Model	3WWDZ-20B
Weight	25.4 kg (excl. battery) 32 kg (inc. battery)
Max Takeoff Weight <sup>[1]</sup>	Max takeoff weight for spraying: 52 kg (at sea level) Max takeoff weight for spreading: 58 kg (at sea level)
Max Diagonal Wheelbase	1925 mm
Dimensions	2585×2675×780 mm (arms and propellers unfolded) 1475×1540×780 mm (arms unfolded and propellers folded) 1050×690×820 mm (arms and propellers folded)
Hovering Accuracy Range (with strong GNSS signal)	D-RTK enabled: Horizontal: ±10 cm, Vertical: ±10 cm D-RTK disabled: Horizontal: ±60 cm, Vertical: ±30 cm (radar module enabled: ±10 cm)
Operating Frequency <sup>[2]</sup>	2.4000-2.4835 GHz, 5.725-5.850 GHz
Transmitter Power (EIRP)	2.4 GHz: <20 dBm (SRRC/CE/MIC), <33 dBm (FCC) 5.8 GHz: <33 dBm (SRRC/FCC), <14 dBm (CE)
RTK/GNSS Operating Frequency	RTK: GPS L1/L2, GLONASS F1/F2, BeiDou B11/B21/B31, Galileo E1/E5b, QZSS L1/L2 GNSS: GPS L1, GLONASS F1, Galileo E1, BeiDou B11, QZSS L1
Hovering Time <sup>[3]</sup>	No payload for spraying: 14.5 min (takeoff weight of 32 kg with a 15.5Ah battery) Fully loaded for spraying: 7 min (takeoff weight of 52 kg with a 15.5Ah battery) No payload for spreading: 14.5 min (takeoff weight of 32 kg with a 15.5Ah battery) Fully loaded for spreading: 6 min (takeoff weight of 58 kg with a 15.5Ah battery)
Max Configurable Flight Radius	2000 m
Max Wind Resistance	6 m/s
Operating Temperature	0° to 45° C (32° to 113° F)

Propulsion System	
<b>Motors</b>	
Stator Size	100×28 mm
KV	59 rpm/V
Power	4600 W/rotor
<b>Propellers</b>	
Diameter	50 in (1270 mm)
Rotors Quantity	4
Dual Atomizing Spraying System	
<b>Spray Tank</b>	
Volume	20 L
Operating Payload <sup>[1]</sup>	20 kg
<b>Sprinklers</b>	
Model	LX8060SZ
Quantity	2
Droplet Size	50-500 μm
Max Effective Spray Width <sup>[4]</sup>	4-7 m (at a height of 3 m above the crops)
<b>Delivery Pumps</b>	
Type	Magnetic drive impeller pump
Max Flow Rate	16 L/min (2 sprinklers)
Phased Array Radar System	
Model	RD241608RF (forward phased array radar) RD241608RB (rear phased array radar)
Terrain Follow	Max slope in Mountain mode: 50° Altitude detection range: 1-50 m Stabilization working range: 1.5-30 m
Obstacle Avoidance <sup>[5]</sup>	Obstacle sensing range (omnidirectional): 1-50 m FOV: Forward phased array radar: horizontal 360°, vertical ±45°, upward ±45° (cone) Rear phased array radar: vertical 360°, horizontal ±45° Working conditions: flying higher than 1.5 m over the obstacle at a horizontal speed no more than 10 m/s and vertical speed no more than 3 m/s. Safety limit distance: 2.5 m (distance between the front of propellers and the obstacle after braking) Sensing direction: multidirectional obstacle sensing
Operating Frequency	24.05-24.25 GHz (NCC/FCC/MIC/KCC/CE)
Power Consumption	23 W (forward phased array radar) 18 W (rear phased array radar)
Transmitter Power (EIRP)	<20 dBm (NCC/FCC/MIC/KCC/CE)
Operating Voltage	DC 15V

Operating Temperature	0° to 45° C (32° to 113° F)
<b>Binocular Vision System</b>	
Measurement Range	0.5-29 m
Effective Sensing Speed	≤10 m/s
FOV	Horizontal: 90°, Vertical: 106°
Operating Environment	Adequate light and discernible surroundings
<b>Remote Controller</b>	
Model	RM700B
GNSS	GPS + Galileo + BeiDou
Screen	7.02-in LCD touchscreen, with a resolution of 1920×1200 pixels, and high brightness of 1200 cd/m <sup>2</sup>
Operating Temperature	-20° to 50° C (-4° to 122° F)
Storage Temperature Range	Less than one month: -30° to 45° C (-22° to 113° F) One to three months: -30° to 35° C (-22° to 95° F) Three months to one year: -30° to 30° C (-22° to 86° F)
Charging Temperature	5° to 40° C (41° to 104° F)
Internal Battery Chemical System	LiNiCoAlO <sub>2</sub>
Internal Battery Runtime	3 hours 18 minutes
External Battery Runtime	2 hours 42 minutes
Charging Type	It is recommended to use a locally certified USB-C charger at a maximum rated power of 65 W and maximum voltage of 20 V such as the DJI 65W Portable Charger.
Charging Time	2 hours for internal battery or internal and external battery (when remote controller is powered off and using a standard DJI charger)
<b>O3 Agras</b>	
Operating Frequency <sup>(2)</sup>	2.4000-2.4835 GHz, 5.725-5.850 GHz
Transmitter Power (EIRP)	2.4 GHz: <33 dBm (FCC), <20 dBm (CE/SRRC/MIC) 5.8 GHz: <33 dBm (FCC), <14 dBm (CE), <23 dBm (SRRC)
Max Transmission Distance	7 km (FCC), 5 km (SRRC), 4 km (MIC/CE) (unobstructed, free of interference, and at an altitude of 2.5 m)
<b>Wi-Fi</b>	
Protocol	Wi-Fi 6
Operating Frequency <sup>(2)</sup>	2.4000-2.4835 GHz, 5.150-5.250 GHz, 5.725-5.850 GHz
Transmitter Power (EIRP)	2.4 GHz: <26 dBm (FCC), <20 dBm (CE/SRRC/MIC) 5.1 GHz: <26 dBm (FCC), <23 dBm (CE/SRRC/MIC) 5.8 GHz: <26 dBm (FCC/SRRC), <14 dBm (CE)
<b>Bluetooth</b>	
Protocol	Bluetooth 5.1
Operating Frequency	2.4000-2.4835 GHz
Transmitter Power (EIRP)	<10 dBm

- [1] The DJI Agras app will intelligently recommend the payload weight limit for the tank according to the current status and surroundings of the aircraft. Do not exceed the recommended payload weight limit when adding material to the tank. Otherwise, the flight safety may be affected.
- [2] 5.8 and 5.1 GHz frequencies are prohibited in some countries. In some countries, the 5.1 GHz frequency is only allowed for use indoors.
- [3] Hovering time acquired at sea level with wind speed lower than 3 m/s and a temperature of 25° C (77° F). For reference only. The data may vary depending on the environment. Actual results shall be as tested.
- [4] The spray width depends on the actual operation scenarios.
- [5] The effective sensing range varies depending on the material, position, shape, and other properties of the obstacle. The downward sensing function is used to assist in Terrain Follow, while the sensing function on the other sides is for obstacle sensing.

## Operation Resumption

When exiting a Route, or Fruit Tree operation, the aircraft will record a breakpoint. The Operation Resumption function allows the user to pause an operation temporarily to refill the spray tank, change the battery, or avoid obstacles manually. Afterwards, resume operation from the breakpoint.

### Recording a Breakpoint

If GNSS signals are strong, a breakpoint will be recorded in the following scenarios during an operation. If GNSS signals are weak, the aircraft will enter Attitude mode and exit the current operation. The last position where GNSS signals were strong will be recorded as a breakpoint.

1. Tap the Pause or End button on the lower right corner of the screen. Note: tapping the End button during an A-B Route operation does not cause the aircraft to record a breakpoint. The operation ends immediately and cannot be resumed.
2. Initialize RTH.
3. Push the pitch or roll stick in any direction on the remote controller.
4. Obstacle detected. The aircraft brakes and enters obstacle avoidance mode.
5. Radar module error detected when its obstacle avoidance function is enabled.
6. The aircraft reaches its distance limit, or the aircraft is close to a GEO zone.
7. Empty tank.
8. The aircraft enters low-battery landing mode.
9. If the option "Continue operation if remote control signal is lost" is disabled in Aircraft Settings, and the aircraft disconnects from the remote controller, the aircraft will record a breakpoint after it performs the action preset for when signals are lost.



- Make sure that the GNSS signal is strong when using the Operation Resumption function. Otherwise, the aircraft cannot record and return to the breakpoint.
  - The breakpoint is updated as long as it meets one of the above conditions.
- 

### Resuming Operation

1. Exit an operation through one of the above methods. The aircraft will record the current location as the breakpoint.
2. Fly the aircraft to a safe location after the conditions for recording a breakpoint are removed.
3. Return Route
  - a. For Route operations, Flight-Efficient Operation Resumption becomes available if any of the following conditions are met. The app will calculate the optimal return point according to the breakpoint and the aircraft location to reduce the flying distance when carrying a heavier payload. Make sure to enable Flight-Efficient Operation Resumption in Flight Optimization under Aircraft Settings before an operation. Users can also enable/disable this function in the menu on the left side of the screen after the aircraft has landed.
    - The aircraft will land on the ground after the operation is paused.

- Exit an operation by tapping the End button and then start this operation again in the Executing tag in the operation list.
- b. For Route operations that do not meet the conditions mentioned above, as well as operations in other modes, the default return route is to fly back to the breakpoint. Users can also select a return point from the list of return points and breakpoint on the screen. After selection, the aircraft will return to the task route following a perpendicular line.



- If connection points are added before the operation, the aircraft will fly back to the breakpoint through the connection points after tapping Resume.
- If an operation has been exited by clicking the End button, the connection points will no longer be available. Add connection points before performing the operation again to avoid obstacles.

4. Tap Resume in the lower right corner of the screen and the aircraft will fly to the task route by following the selected return route and continue spraying. For Route and Fruit Tree operations, Connection Routing is supported for return flights. The aircraft will fly back to the breakpoint through the connection points.
5. The aircraft will automatically bypass the marked obstacles when flying back to the breakpoint or return point. Users can also manually control the aircraft to avoid obstacles. Refer to the Manual Obstacle Avoidance section for more information.

## Typical Applications

In Route, or Fruit Tree operation mode, users can control the aircraft forward, backward, and sideward, avoiding obstacles along the operation route, or in an emergency such as when the aircraft is experiencing abnormal behavior. The following instructions describe how to avoid obstacles manually:

## Manual Obstacle Avoidance

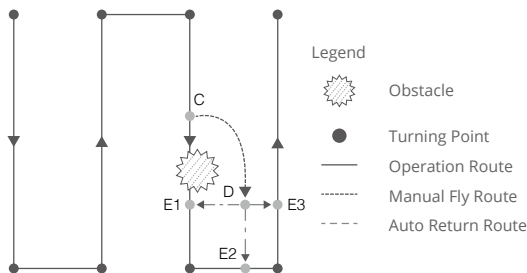

### 1. Exiting a Route, or Fruit Tree operation

In these modes, when using the control sticks to control the aircraft forward, backward, or sideward, the aircraft automatically switches the current mode to Manual operation mode, pauses the operation, records the current position as a breakpoint (Point C), completes the corresponding flight behavior, and hovers.

- 
- ⚠ • When pushing the control sticks to exit the operation, the aircraft requires a braking distance. Make sure that there is a safe distance between the aircraft and any obstacles.
- 

2. Avoiding an Obstacle

After switching to Manual operation mode, users can control the aircraft to avoid the obstacle from Point C to D.

3. Resuming Operation

Select one of the three return points marked as E1, E2, or E3. Tap Resume and the aircraft flies from the point marked D to the selected return point following a perpendicular line.

---

- ⚠ • The amount of selectable return points is related to the position of the aircraft. For example, there is no E2 (points on non-spraying route) for Route operation mode. Select according to the app display.
  - Make sure that the aircraft has completely avoided the obstacle before resuming operation.
  - In the event of an emergency, make sure that the aircraft is operating normally and fly the aircraft manually to a safe area to resume operation.
- 

- 🚨 • Repeat the instructions above to exit and resume operation in the event of an emergency when returning to the route, such as whenever obstacle avoidance is required.
- 

## System Data Protection

In Route, or Fruit Tree operation mode, the System Data Protection feature enables the aircraft to retain vital system data such as operation progress and breakpoints after the aircraft is powered off to replace a battery or refill the spray tank. Follow the instructions in Operation Resumption to resume the operation after restarting the aircraft.

During Route operations, in situations such as when the app crashes or the remote controller disconnects from the aircraft, the breakpoint will be recorded by the flight controller and recovered automatically in the app once the aircraft is reconnected. If recovery is not performed automatically, users can perform the operation manually. Go to Aircraft Settings in the app and tap Restore Unfinished Task. Recall the operation in the Executing tag in the operation list.

## Empty Tank Warning

### Profile

The aircraft calculates the empty tank and refill points according to the preset remaining liquid level threshold, current remaining liquid level, aircraft status, and operation parameters and displays the empty tank point on the map. In Route, Manual, and Fruit Tree operations, users can set the action the aircraft will perform for empty tank point.



- The empty tank point will not be displayed on the map if the tank is not calculated to run out before the end of the task route.
  - For Route (Field) operations, when adding liquid to the spray tank or adjusting the operation parameters, the empty tank point will update dynamically on the operating route according to the amount of added liquid and the adjusted settings.
- 

## Usage

1. In Aircraft settings, enable the display of empty tank point and set the empty tank action.
2. When an empty tank warning appears in the app, the sprinklers automatically turn off and the aircraft performs the preset empty tank action.
3. Land the aircraft and stop the motors. Refill the spray tank and tightly secure the cover.
4. Select an operation mode and continue the operation.

## Return to Home (RTH)

---



**Home Point:** The default home point is the first location where your aircraft received strong GNSS signals (when the GNSS icon is green). Note that the white GNSS icon requires at least four bars before the signal is strong.

**RTH:** RTH brings the aircraft back to the last recorded home point.

---

There are three types of RTH: Smart RTH, Low Battery RTH, and Failsafe RTH.

### Smart RTH

Press and hold the RTH button on the remote controller when GNSS is available to enable Smart RTH. Both Smart and Failsafe RTH use the same procedure. With Smart RTH, you may control the altitude of the aircraft to avoid collisions when returning to the home point. Press the RTH button once or push the pitch stick to exit Smart RTH and regain control of the aircraft.

### Low Battery RTH

Low Battery RTH is only available in Route and Fruit Tree operations. If the Low Battery Action is set to RTH in the Aircraft Battery settings in the app, the aircraft will pause the operation and enter RTH automatically when the aircraft battery level reaches the low battery threshold. During RTH, users can control the altitude of the aircraft to avoid collisions when returning to the home point. Press the RTH button once or push the pitch stick to exit RTH and regain control of the aircraft.

The aircraft will not enter RTH if the Low Battery Action is set to Warning in the Aircraft Battery settings in the app.

### Failsafe RTH

Refer to Emergency Procedures for more information about Failsafe RTH.

## Updating the Home Point







You can update the home point in DJI Agras during flight. There are two ways to set a home point:

1. Set the current coordinates of the aircraft as the home point.
2. Set the current coordinates of the remote controller as the home point.



- Make sure the space above the remote controller's GNSS module (located inside the place above the flight mode switch) is not obstructed and that there are no tall buildings around when updating the home point.

Follow the instructions below to update the home point:

1. Go to DJI Agras and enter Operation View.
2. Tap , then , and select  Set Aircraft Location to set the current coordinates of the aircraft as the home point.
3. Tap , then , and select  Set Controller Location to set the current coordinates of the remote controller as the home point.
4. The aircraft status indicators blink green to indicate that the new home point has been set successfully.

## Low Battery and Low Voltage Warnings

The aircraft features a low battery warning, critical low battery warning, and critical low voltage warning.

1. When the low battery warning prompt appears in the app, fly the aircraft to a safe area and land as soon as possible. Stop the motors and replace the battery. The aircraft will enter RTH automatically after the low battery warning prompt appears in the app if the Low Battery Action is set to RTH in the Aircraft Battery settings.
2. The aircraft will automatically descend and land when the critical low battery warning or critical voltage warning (battery voltage lower than 47.6 V) prompt appears in the app. Landing cannot be cancelled.



- Users can set the threshold of low battery warnings in the app.

## RTK Functions

The aircraft has an onboard D-RTK. The heading reference of the aircraft from the dual antennas of the onboard D-RTK is more accurate than a standard compass sensor and can withstand magnetic interference from metal structures and high-voltage power lines. When there is a strong GNSS signal, the dual antennas activate automatically to measure the heading of the aircraft.

The aircraft supports centimeter-level positioning to improve agricultural operation when used with the DJI D-RTK 2 Mobile Station. Follow the instructions below to use the RTK functions.

## Enable/Disable RTK

Before each use, make sure that the RTK signal source is correctly set to either D-RTK 2 Mobile Station or Network RTK. Otherwise, RTK cannot be used for positioning. Go to Operation View in the app, tap , and select RTK to view and set.

Disable RTK Positioning if RTK is not in use. Otherwise, the aircraft is not able to take off when there is no differential data.

## Using with the DJI D-RTK 2 Mobile Station

1. Refer to the D-RTK 2 Mobile Station User Guide for more information about completing the linking between the aircraft and the mobile station and setting up the mobile station.
2. Power on the mobile station and wait for the system to start searching for satellites. The RTK status icon on top of the Operation View becomes green to indicate that the aircraft has obtained and used the differential data from the mobile station.

## Using with the Network RTK Service

The Network RTK service uses the remote controller instead of the base station to connect to an approved Network RTK server for differential data. Keep the remote controller powered on and connected to the internet when using this function.

1. Make sure the remote controller is connected to the internet.
2. In the app, go to Operation View, tap  and then RTK to select RTK Signal Type to Custom Network RTK, and input the network information.
3. Wait for the remote controller to be connected with the Network RTK server. The RTK status icon at the top of the Operation View will turn green, indicating that the aircraft has obtained and used the RTK data from the server.

## Aircraft LEDs

There are LEDs on the frame arms marked M1 to M4. The LEDs on frame arms M1 and M2 are front LEDs that blink slowly in red to indicate the front of the aircraft. The LEDs on frame arms M3 and M4 are rear LEDs that blink slowly in green to indicate the rear of the aircraft. All the LEDs are turned off when the aircraft is grounded. The front LEDs blink quickly in red and the rear LEDs blink quickly in green when the motors start spinning. Make sure to take off immediately.

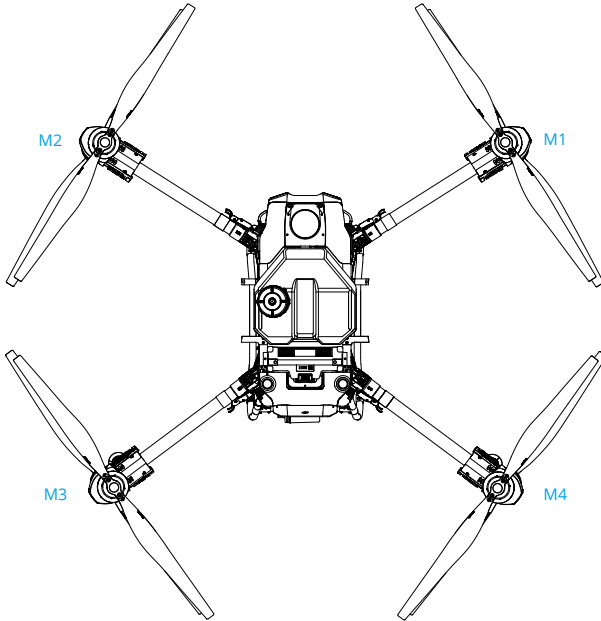

## Updating the Firmware

The firmware of the remote controller, aircraft, and other devices such as the intelligent charger and multifunctional inverter generator can be updated together in the DJI Agras app. Follow the steps below.

1. Power on the remote controller and the aircraft. Make sure that the remote controller has access to the internet via Wi-Fi or the cellular dongle. The firmware file may be large. It is recommended to use Wi-Fi.
2. A prompt appears at the bottom of the home screen in DJI Agras when a new firmware update is available. Tap Device Management and then Firmware Update.
3. Connect the device to the USB-A port on the remote controller to update the firmware of the intelligent charger or multifunctional inverter generator. Tap the dropdown menu for each device and select the firmware. There will be a check mark on the device displayed in the app when a firmware is selected for the corresponding device. Uncheck the mark to cancel the update.
4. Tap Update All Selected to redirect to the update screen. The app will download the firmware for all selected devices and update automatically.
5. Make sure all the devices are connected to the remote controller and wait for the update to complete. The aircraft front LEDs will blink yellow during an update.
6. The aircraft front indicators will glow solid green after an update is completed. Restart the remote controller and the aircraft manually. If the indicators glow solid red indicating that a firmware update has failed, try running the update again.

## DJI Assistant 2 (MG Series)

Configure settings of the basic parameters, copy flight records, and update aircraft and remote controller firmware in DJI Assistant 2 (MG Series).

## Installation and Launching

1. Download the DJI Assistant 2 (MG Series) installation file from the T50 or T25 download page:  
<https://www.dji.com/downloads/softwares/assistant-dji-2-for-mg>
2. Install and launch the software.

## Using DJI Assistant 2 (MG Series)

### Connecting the Aircraft

Connect the USB-C port under the bottom cover on the front of the aircraft to a computer with a USB-C cable, and then power on the aircraft.



- Make sure to remove the propellers before using the software.
-



- Remove the waterproof cover on the USB-C port before use. Attach the waterproof cover to the port after use. Otherwise, water may enter the port, causing it to short circuit.

---

## Firmware Update

A DJI account is required for firmware updates. Login or register an account.

## Exporting Log

View all the logs of the aircraft and select logs to export.

## Simulator

Click Open to enter the flight simulation view. Input location and environment parameters and click Configure to save. Click Start Simulation to enter flight simulation practice.

## Basic Settings

Configure the idle speed of and test the motor.

## Connecting the Remote Controller

Connect the USB-C port of the remote controller to a computer with a USB-C cable and power on the remote controller.

## Firmware Update

A DJI account is required for firmware updates. Login or register an account.

## Exporting Log

View all the logs of the remote controller and select the logs to export.



- DO NOT power off the remote controller during the update.
- DO NOT perform the firmware update while the aircraft is in the air. Only carry out the firmware update when the aircraft is on the ground.
- The remote controller may become unlinked from the aircraft after the firmware update. Relink the remote controller and aircraft if necessary.

---

# Intelligent Flight Battery

## Battery Functions

1. Battery Level Display: the status LEDs indicate the current battery level. Press the power button to check.
2. Communication: battery parameters including the voltage and power level are transmitted to the aircraft to enable the aircraft to take appropriate action when battery parameters change.

3. Battery Error Self-Diagnosis: the battery can detect errors such as abnormal voltage, current, and temperature, and issue an alert. The error information will be recorded in the battery.
4. Short Circuit Detection: after the battery is inserted into the aircraft and powered on, the battery will first detect if a short circuit exists on the aircraft. If detected, the battery will cut off the power supply to the aircraft to avoid fire.
5. Charging Error Detection: errors that occur during charging are indicated by the status LEDs. When an error occurs, wait for the battery to fix the error automatically. For more information, refer to the LED Patterns section.
6. Auto Balancing: in certain situations, the battery automatically balances the voltages of the cells.
7. Auto Discharging: if fully charged for more than one day, the battery automatically discharges to 97%. After 7 days, it automatically discharges to 60%.
8. Auto Current Adjustment: the battery intelligently adjusts the charging current based on the temperature of the battery cells. The battery also supports self-protection based on the environment temperature.
9. Temperature Control: the battery ensures the temperature difference between the battery cells are the same and stay within the allowable temperature range.

- 
-  • Refer to the safety requirements listed on the label of the battery before using for the first time. Users accept full responsibility for any violations of the safety requirements stated on the label.
- The product warranty is void if any battery errors occur due to misuse of the battery.
- 

## Using the Battery

Press and then press and hold the power button to power on the battery after it is connected to the aircraft. When the aircraft lands and the motors stop, press and then press and hold the power button to power off the battery, and then disconnect the battery from the aircraft.

- 
-  • DO NOT use the battery near heat sources such as a furnace or heater. DO NOT leave the battery inside a vehicle on hot days.
- DO NOT allow the battery to come into contact with any liquid. DO NOT leave the battery near a source of moisture and DO NOT use the battery in humid environments. Otherwise, the battery may corrode, potentially resulting in the battery catching fire or exploding.
  - DO NOT use swollen, leaking, or damaged batteries. If your battery is abnormal, contact an authorized DJI dealer for further assistance.
  - Make sure the battery is powered off before connecting to or disconnecting from the aircraft. DO NOT connect or disconnect the battery while it is powered on. Otherwise, the power ports may be damaged.
  - The battery should be used in the temperature range of -5° to 45° C (23° to 113° F). Use of batteries in environments above 50° C (122° F) can lead to fire or an explosion. Use of the battery in temperatures below -5° C (23° F) can negatively affect the performance of the battery. The battery can be used again when it returns to a normal temperature.

- DO NOT use the battery in strong electrostatic or electromagnetic environments or near high-voltage transmission lines. Otherwise, the battery circuit board may malfunction, which could cause a serious flight hazard.
- DO NOT disassemble or pierce a battery in any way or it may leak, catch fire, or explode.
- The electrolytes in the battery are highly corrosive. If any electrolytes make contact with your skin or eyes, immediately wash the affected area with water and see a doctor immediately.
- DO NOT use a battery that has been dropped. Dispose of the battery as described in the Battery Disposal section.
- If the battery falls into water while inserted in an aircraft during flight, remove it immediately, and contact a DJI authorized dealer to check and repair the aircraft and intelligent flight battery as soon as possible.
- Extinguish any battery fire using water, sand, or a dry powder fire extinguisher.
- DO NOT put the battery in a microwave oven or a pressurized container.
- DO NOT place the battery on or near wires or other metal objects such as eyeglasses, watches, jewelry, and hairpins. Otherwise, the battery ports may be short-circuited.
- DO NOT drop or strike batteries. DO NOT place heavy objects on the batteries or station. Avoid dropping batteries.
- Always use a clean, dry cloth when cleaning the battery terminals.
- DO NOT fly when the battery power level is below 15% to avoid damage to the battery and flight risks.
- Make sure the battery is correctly connected. Otherwise, the battery may overheat or even explode due to abnormal charging. Only use approved batteries from authorized dealers. DJI assumes no responsibility for any damaged caused by using batteries that are unapproved.
- Make sure to lift the battery by the handle.
- Make sure the battery is placed on a flat surface to avoid damage to the battery from sharp objects.
- DO NOT place anything on a battery. Otherwise, the battery may be damaged, which may lead to fire hazards.
- The battery is heavy. Be careful when moving the battery to avoid dropping it. If the battery is dropped and damaged, immediately leave the battery in an open area away from people. Wait 30 minutes and soak the battery in water for 24 hours. After making sure the power has completely run out, dispose of the battery in accordance with local laws.
- Make sure the battery is fully charged before each flight.
- Immediately land the aircraft if a critical battery level warning appears and replace with a fully charged battery.
- Before operating in a low-temperature environment, make sure the battery is at least above 5° C (41° F). Ideally, above 20° C (68° F).

## LED Patterns

 The Battery Level Indicators will show the current battery level and status during charging and discharging. The indicators are defined below:

































 LED is on

 LED is blinking

 LED is off





















### Checking Battery Level

If the battery is in power saving mode, press the power button once to check the current battery level.

LED1	LED2	LED3	LED4	Battery Level
				88%~100%
				76%~87%
				63%~75%
				51%~62%
				38%~50%
				26%~37%
				13%~25%
				0%~12%

















### LED Patterns During Charging





















During charging, the LEDs blink in sequence to indicate the current battery level. All the LEDs will be off after a full charge. Disconnect the battery when charging is complete, and always use the officially recommended charging device to charge the battery.

LED1	LED2	LED3	LED4	Battery Level
				0-49%
				50-74%
				75-89%
				90-99%
				100%

### Battery Error LED Patterns

The table below shows battery protection mechanisms and corresponding LED patterns.

LED1	LED2	LED3	LED4	Blinking Pattern	Description
				LED2 and LED4 blink three times per second	Aircraft short circuit/overcurrent at power on
				LED2 and LED4 blink two times per second	Undervoltage at power on
				LED2 blinks twice per second	Overcurrent detected
				LED2 blinks three times per second	The battery system is abnormal

				LED3 blinks twice per second	Overcharged detected
				LED3 blinks three times per second	Charging device over-voltage
				LED4 blinks twice per second	Temperature is too low when charged/power on
				LED4 blinks three times per second	Temperature is too high when charged/power on
				All 4 LEDs blink fast	The battery is abnormal and unavailable

If overcurrent at power on is detected or a short circuit occurs, unplug the battery, then check if there are foreign objects in the port.

If undervoltage at power on is detected, charge the battery before use.

If the battery temperature is abnormal, wait for the temperature to return to normal. The battery will then automatically power on or resume charging.

For other situations, after resolving the issue (overcurrent, excess battery voltage due to overcharging, or excess charging device voltage), press the power button to cancel the LED indicator protection alert and unplug and plug in the charging device again to resume charging.



- DJI does not take any responsibility for damage caused by third-party charging devices.
- DO NOT charge the battery near flammable materials or on flammable surfaces such as carpet or wood. DO NOT leave the battery unattended during charging. There should be a distance of at least 30 cm between the battery station and any charging batteries. Otherwise, the battery station or charging batteries may be damaged by excessive heating and may even lead to a fire hazard.
- The battery temperature will be high after a flight. Place the battery into the DJI Air-Cooled Heat Sink or a third-party air-cooled heat dissipation device to charge it. Otherwise, charging may be disabled. Refer to the DJI Air-Cooled Heat Sink manual document for its usage instructions. Charge the battery at a temperature range of 0° to 60° C (32° to 140° F). The ideal charging temperature range is 22° to 28° C (72° to 82° F). Charging within the ideal temperature range can prolong battery life.
- DO NOT immerse the battery in water to cool it down or when it is charging. Otherwise, the battery cells will corrode causing serious damage to the battery. The user accepts full responsibility for any damage to the battery caused by immersing the battery in water.
- DO NOT charge the battery near heat sources such as a furnace or heater.
- Regularly check the terminals and battery ports. DO NOT clean the battery using alcohol or other inflammable liquid. DO NOT use a damaged charging device.
- Keep the battery dry at all times.
- The battery stops charging when charging is complete. It is recommended to disconnect the battery once charging is complete.
- Make sure the battery is powered off before charging. Otherwise, the battery ports may be damaged.

## Battery Storage and Transportation

Disconnect the battery from the aircraft and check if there is any buildup in the battery port.

---

- ⚠ • Power off and disconnect the battery from the aircraft or other devices during transportation.
  - Keep batteries out of the reach of children and animals. Seek professional medical support immediately if children swallow parts of the battery.
  - If the battery level is critically low, charge the battery to a power level of 40% to 60%. DO NOT store a battery with a low power level for an extended period. Otherwise, the performance will be negatively affected.
  - DO NOT leave the battery near heat sources such as a furnace or heater. DO NOT leave the battery inside a vehicle on hot days.
  - The battery must be stored in a dry environment.
  - DO NOT place the battery near explosive or hazardous material or near metal objects such as eyeglasses, watches, jewelry, and hairpins.
  - DO NOT attempt to transport a battery that is damaged or has more than 30% power. Discharge the battery to 25% or lower before transportation.
  - Make sure the battery is placed on a flat surface to avoid damage to the battery from sharp objects.
  - If storing the battery for more than three months, it is recommended to store the battery in a battery safety bag in an environment at a temperature range from -20° to 40° C (-4° to 104° F).
  - DO NOT store the battery for an extended period after fully discharging. Doing so may over-discharge the battery and cause irreparable damage to the battery cell.
  - If a battery with a low power level has been stored for an extended period, the battery will be in deep hibernation mode. Charge to wake the battery.
  - Disconnect the battery from the aircraft if you intend to store the battery for an extended period.
- 

## Battery Disposal

- ⚠ • It is recommended to open the battery cover and put it in a 5% salt solution for more than two weeks to completely discharge the battery. Then dispose of the battery in specific recycling boxes. Contact the official support or an authorized dealer if you have any problems.
  - DO NOT place the battery in regular waste containers. Strictly follow your local regulations regarding the disposal and recycling of batteries.
  - If the battery cannot be discharged completely, DO NOT dispose of the battery in a battery recycling box directly. Contact a professional battery recycle company for assistance.
-

## Battery Maintenance

---

- ⚠ • DO NOT splash the battery with water. An excessive amount of water will damage the battery.
  - DO NOT store the battery when the temperature is outside the range of -20° to 45° C (-4° to 113° F).
  - Battery performance will be negatively affected if the battery is not used for an extended period.
  - Fully charge and discharge the battery at least once every three months to ensure the performance of the battery.
  - If a battery has not been charged or discharged for five months or more, the battery will no longer be covered by the warranty.
-

## Specifications

Specifications	DB1560 Intelligent Flight Battery (BAX702-30000mAh-52.22V)	DB800 Intelligent Flight Battery (BAX702-15500mAh-52.22V)
Nominal Voltage	52.22 V	
Battery Type	Li-ion	
Battery Chemical System	LiNiMnCoO <sub>2</sub>	
Discharge Rate	11.5C	
Operating Temperature	-5° to 45° C (23° to 113° F)	
Charging Temperature	0° to 60° C (32° to 140° F)	
Warranty Details	1,500 cycles or 12 months (whichever occurs first)	
IP Rating	IP54 + Board-level potting protection	
Compatible Aircraft	DJI Agras T50, T25, T40, T20P, T30	DJI Agras T25, T20P
Capacity	30000 mAh	15500 mAh
Energy	1567 Wh	809 Wh
Max Charging Power	9500 W	5400 W
Compatible Charging Device <sup>(1)</sup>	D12000iEP Multifunctional Inverter Generator C10000 Intelligent Charger D12000iE Multifunctional Inverter Generator <sup>(2)</sup> C8000 Intelligent Battery Station <sup>(2)</sup> T40 Intelligent Charger <sup>(2)</sup> T30 Intelligent Battery Station <sup>(2)</sup> D9000i Multifunctional Inverter Generator <sup>(2)</sup>	D6000i Multifunctional Inverter Generator <sup>(2)</sup> C8000 Intelligent Battery Station <sup>(2)</sup> D9000i Multifunctional Inverter Generator <sup>(2)</sup> T30 Intelligent Battery Station <sup>(2)</sup>
Charging Time for Each Battery <sup>(3)</sup>	Using the D12000iEP Multifunctional Inverter Generator: 9-12 min	Using the D6000i Multifunctional Inverter Generator: 9-12 min
Weight	Approx. 12.1 kg	Approx. 6.6 kg

[1] Charging devices available for purchase vary by country or region. Consult your local dealers for details.

[2] Firmware update is required to charge the DB1560/DB800 Intelligent Flight Battery.

[3] Charging time was tested in a lab environment at a temperature of 25° C (77° F). For reference only.

## Payload - Spraying System

### Introduction

Equipped with the 2-channel electromagnetic flow meter and continuous liquid level gauge, the spraying system provides users with accurate control of the magnetic drive impeller pumps and dual atomizing sprinklers.

### Spraying Operation Parameters

To achieve optimal spraying results, the following parameters are offered for reference.

1. Aircraft altitude: 3-4 m
2. Flight speed: 4-6 m/s
3. Droplet size:
  - a. pesticide: 50-300  $\mu\text{m}$
  - b. herbicide: 400-500  $\mu\text{m}$
  - c. fungicide: 200-500  $\mu\text{m}$  (vary depending on crops)

-  • The data was measured at a wind speed lower than 3.4 m/s, using T50 with two sprinklers and the operation mode was set in Route operation.
- Set the parameters according to the environmental conditions, terrain, and crop species. The above data is for reference only.

### Specifications

Items	T50 Spraying System	T25 Spraying System
Spray Tank Volume	40 L	20 L
Operating Payload	40 kg	20 kg
Effective Spray Width (at a height of 3 m above the crops)	4-11 m	4-7 m
Max Flow Rate	16 L/min (2 sprinklers) 24 L/min (4 sprinklers)	
Sprinkler Model	LX8060SZ	
Sprinkler Quantity	2	
Droplet Size	50-500 $\mu\text{m}$	
Pump Type	Magnetic drive impeller pump	

## Optional Payload - T50/T25 Spreading System

### Introduction

The T50/T25 Spreading System is compatible with the Agras T50/T25 aircraft with a large spread tank of 75 L and 35 L, respectively, and offers efficient and reliable spreading.

The spreading system is equipped with the all-new spinner disk to spread more evenly. The control module on the spreading system and the weight sensors on the aircraft monitor the weight of the remaining material in the spread tank in real-time to improve the accuracy of the spread rate control and empty tank warnings. The updated fenders can block spreading material that flies upward and prevent it from damaging the propellers. The quick-release hopper gate allows for easy maintenance and can be replaced easily with the small flow hopper gate when spreading materials with small flow or diameter.

Users can configure spreading settings in the DJI Agras app and create specific templates for different materials in order to meet different requirements. The app also provides warning prompts for an empty tank as well as for abnormalities in rotational speed, temperature, and hopper outlet size.

### Installation

- 
- ⚠ • Make sure to remove the Intelligent Flight Battery from the aircraft before installation.
  - Operate with caution to avoid injury caused by sharp or moving mechanical parts.
  - Check the parts on the aircraft and spreading system after installation to make sure that the spinner disk will not damage the cables or any other part during operations.
- 

The T50 Spreading System and T25 Spreading System are similar in appearance and operations. Unless otherwise specified, the illustrations in this document use the T50 Spreading System as an example.

1. On the aircraft, locate the hoses on either side of the spray tank. Loosen the nut on the hose ① and detach the hose and nut. (Figure A)  
Note: after the hose is removed, make sure to tighten the hose nut on the spray tank hose connector to avoid losing the nut.
2. Locate the spraying system cable in the rear of the left landing gear on the aircraft. Move the protective rubber on the cable ② and unplug the cable from the connector ③. Operate with caution to avoid damaging the cable. (Figure B)
3. Lift and remove the spray tank on the aircraft. (Figure C)
4. Tilt the spreading system to the side with the cable, insert the spreading system into the aircraft and rotate. The spreading system needs to be inserted at an angle. DO NOT insert by force. (Figure D)
5. Connect the spreading system cable to the connector in step 2 and ensure a firm and accurate connection ①. Move the protective rubber back ②. (Figure E)

A.

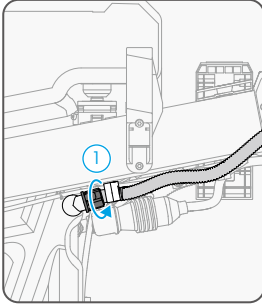

B.

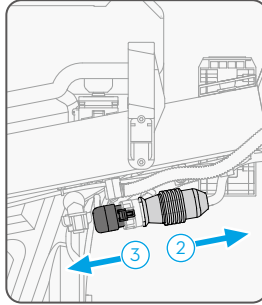

C.

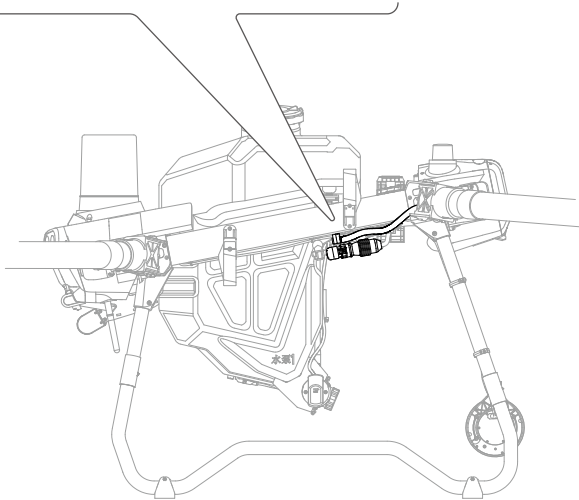
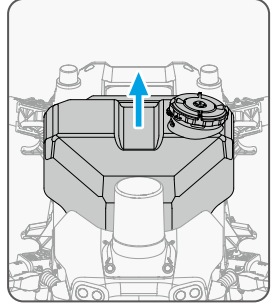

D.

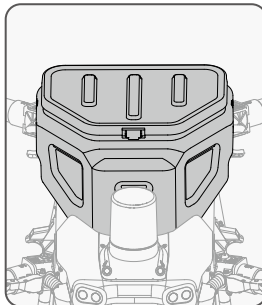
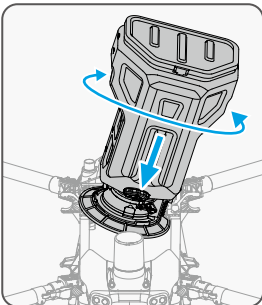

E.

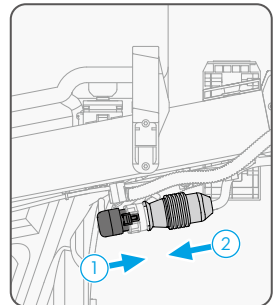

## Specifications

Items	T50 Spreading System	T25 Spreading System
Compatible Aircraft <sup>[1]</sup>	Agras T50	Agras T25
Spreading System Weight (inc. spread tank and fender)	6.0 kg	3.9 kg
Spread Tank Volume	75 L	35 L
Spread Tank Internal Load <sup>[2]</sup>	50 kg	25 kg
Compatible Material Diameter	0.5-5 mm	
Spreading Range	Varies according to material diameter, spinner disk rotating speed, hopper outlet size, and flying altitude. For best operating performance, it is recommended to adjust the corresponding variables to achieve a spreading range of 4.5-7 meters.	

- [1] The aircraft firmware must support the spreading system. Check the release notes of the corresponding aircraft on the official DJI website.
- [2] The DJI Agras app will intelligently recommend the payload weight limit for the spread tank according to the current status and surroundings of the aircraft. Do not exceed the recommended payload weight limit when adding material to the spread tank. Otherwise, the flight safety may be affected.

## T50/T25 Drone Recommended Maintenance Cycle

Part for service	Module	Recommended service time	Recommended replacement cycle
Propulsion system - motor	Motor	<ol style="list-style-type: none"> <li>1. Carry out the first inspection for a new drone after 100 flights.</li> <li>2. Carry out an inspection every 100h after the first inspection.</li> <li>3. If an ESC is stalling, and temperature of the motor/ESC is abnormal, carry out this inspection.</li> <li>4. If the motor is damaged due to external force, carry out this inspection.</li> </ol>	Replacement after 1,000h of usage is recommended.
Propulsion system - motor internal resistance	Motor	<ol style="list-style-type: none"> <li>1. Carry out the first inspection for a new drone after 100 flights.</li> <li>2. Carry out an inspection every 100h or 1 month after the first inspection.</li> <li>3. If an ESC is stalling, and temperature of the motor/ESC is abnormal, carry out this inspection.</li> </ol>	Replacement after 1,000h of usage is recommended.
Propulsion system - ESC	ESC	Every 6 months	Replacement after 36 months of usage is recommended.
Propulsion system - motor base	Motor Base	<ol style="list-style-type: none"> <li>1. Carry out the first inspection for a new drone after 100 flights.</li> <li>2. Carry out an inspection every 100h or 1 month after the first inspection.</li> <li>3. If the motor base is damaged due to external force, carry out this inspection.</li> </ol>	Replacement after 500 hours of usage is recommended.
Propulsion system - propellers	Propellers	<ol style="list-style-type: none"> <li>1. Carry out the first inspection for a new drone after 100 flights.</li> <li>2. Carry out an inspection every 100h or 1 month after the first inspection.</li> <li>3. If an ESC is stalling, and temperature of the motor/ESC is abnormal, carry out this inspection.</li> </ol>	Replacement after 700 hours of usage is recommended.
Propulsion system - propeller adapter	Propeller Adapter	Before daily operation preparation	Replacement after 1,000h of usage is recommended.
Propulsion system - screw bolts of frame arm	Screw Bolts of Frame Arm	Every 1 month	Replacement after 1,000h of usage is recommended.

Aircraft components - frame arm connector	Frame Arm Connector	Every 1 month	Replacement after 1,000h of usage is recommended.
Aircraft components - screws	Securing screws of frame arm buckle	Every 1 month	Replacement after 1,000h of usage is recommended.
Aircraft components - connector	Aircraft Connector	Every 1 month	Replacement after 1,000h of usage is recommended.
Middle frame fixing piece - screws	Screw securing the middle frame	Every 1 month	Replacement after 1,000h of usage is recommended.
Landing gear components - screws	Screw Bolts Securing the Landing Gear	Every 1 month	Replacement after 1,000h of usage is recommended.
Landing gear components - fixing bracket	Radar Fixing Bracket	Every 1 month	Replacement after 1,000h of usage is recommended.
Spraying system - delivery pump	Delivery Pump	Every 100h or 1 month	Pump replacement after 500h of usage is recommended. Motor replacement after 1,000h of usage is recommended.
Spraying system - sprinkler	Sprinkler	Every 100h or 1 month	Replacement after 1,000h of usage is recommended.
Spraying system - hose connector	Hose Connector	Before daily operation preparation	Replacement after 1,000h of usage is recommended.
Spraying system - hose	Hose	Before daily operation preparation	Replacement after 1,000h of usage is recommended.
Spraying system - weight sensor	Weight Sensor	Every 100h or 1 month	Replacement after 1,000h of usage is recommended.
Spraying system - filter and liquid level gauge	Liquid Level Gauge	Before daily operation preparation	Replacement after 1,000h of usage is recommended.
Spraying system - spray tank	Spraying System	Every 6 months	Replacement after 1,000h of usage is recommended.
RF module	RF Module	Every 6 months	Replacement after 36 months of usage is recommended.
Aerial-electronics system module	Aerial-Electronics System Module	Every 6 months	Replacement after 36 months of usage is recommended.

Cable distribution board module	Cable Distribution Board Module	Every 6 months	Replacement after 36 months of usage is recommended.
Spraying module	Spraying Module	Every 6 months	Replacement after 36 months of usage is recommended.
Radar system - omnidirectional digital radar	Omnidirectional Digital Radar	Every 6 months	Replacement after 36 months of usage is recommended.
Radar system - backward and downward radar	Backward and Downward Radar	Every 6 months	Replacement after 36 months of usage is recommended.
Power distribution module	Power Distribution Module	Every 6 months	Replacement after 36 months of usage is recommended.
Aircraft components - front frame	Front Frame	Every 6 months	Replacement after 1,000h of usage is recommended.
Aircraft components - rear frame	Rear Frame	Every 6 months	Replacement after 1,000h of usage is recommended.
Aircraft components - middle frame	Middle Frame	Every 6 months	Replacement after 1,000h of usage is recommended.
Positioning system - SDR antenna	SDR Antenna	Every 6 months	Replacement after 36 months of usage is recommended.
Positioning system - RTK module	RTK Module	Every 6 months	Replacement after 36 months of usage is recommended.
Aircraft cables	Aircraft Cable	Every 1 month	Replacement after 36 months of usage is recommended.
Spraying system - flow meter	Flow Meter	Every 1 month	Replacement after 36 months or 3,000h of usage is recommended.
Aircraft components - battery slider	Battery Slider	Replacement after 2,000 times of plugging and unplugging is required or 1 month	Replacement after 1,000h of usage is recommended.
Remote controller	Remote controller	Every 1 month	Replacement after 36 months of usage is recommended.
Battery	Aircraft Standard Battery	After 100 cycles of charging or 1 month	Replacement after 1,000h of usage is recommended.
Intelligent Charger	Intelligent Charger	After 200 cycles of charging or 1 month	Replacement after 1,000h of usage is recommended.

## FAR Remote ID Compliance Information

The aircraft complies with the requirements of 14 CFR Part 89:

- The aircraft automatically initiates a pre-flight self-test (PFST) of the Remote ID system before takeoff and cannot take off if it does not pass the PFST<sup>[1]</sup>. The results of the PFST of the Remote ID system can be viewed in a DJI flight control app such as DJI Agras.
- The aircraft monitors the Remote ID system functionality from pre-flight to shut down. If the Remote ID system malfunctions or has a failure, an alarm will be displayed in a DJI flight control app such as DJI Agras.
- The user shall keep the DJI flight app running in the foreground and always allow it to obtain the location information of the remote controller.

[1] The pass criterion for PFST is that the hardware and software of the Remote ID required-data source and transmitter radio in the Remote ID system are functioning properly.



The terms HDMI, HDMI High-Definition Multimedia Interface, HDMI trade dress and the HDMI Logos are trademarks or registered trademarks of HDMI Licensing Administrator, Inc.



Contact  
DJI SUPPORT

This content is subject to change without prior notice.

Download the latest version from  
**<https://ag.dji.com/t25/downloads> or <https://ag.dji.com/t50/downloads>**

If you have any questions about this document, please contact DJI by  
sending a message to **[DocSupport@dji.com](mailto:DocSupport@dji.com)**.

DJI and AGRAS are trademarks of DJI.

Copyright © 2025 DJI All Rights Reserved.